

Σ -7-Series AC Servo Drive MECHATROLINK-II Communications Command Manual

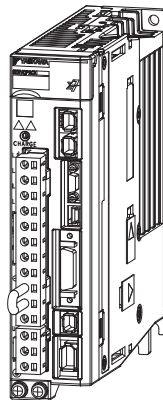

Settings for MECHATROLINK-II Communications	1
Data Field	2
Main Commands	3
Subcommands	4
Operation Sequence	5
Command Related Parameters	6
Detecting Alarms/Warnings Related to Communications or Commands	7
Appendix	8

Copyright © 2014 YASKAWA ELECTRIC CORPORATION

All rights reserved. No part of this publication may be reproduced, stored in a retrieval system, or transmitted, in any form, or by any means, mechanical, electronic, photocopying, recording, or otherwise, without the prior written permission of Yaskawa. No patent liability is assumed with respect to the use of the information contained herein. Moreover, because Yaskawa is constantly striving to improve its high-quality products, the information contained in this manual is subject to change without notice. Every precaution has been taken in the preparation of this manual. Nevertheless, Yaskawa assumes no responsibility for errors or omissions. Neither is any liability assumed for damages resulting from the use of the information contained in this publication.

About this Manual

This manual describes the specifications of MECHATROLINK-II commands used in MECHATROLINK-II communications for the following MECHATROLINK-II communications reference input type SERVOPACKs, the basic operations using these commands, and the parameters for these commands.

- Σ -7-Series Σ -7S SERVOPACKs (Models: SGD7S-□□□□10□)

Read and understand this manual to ensure correct usage of the Σ -7-Series AC Servo Drives.

Keep this manual in a safe place so that it can be referred to whenever necessary.

- Targeted Readers

Users who incorporate the MECHATROLINK-II commands in controllers

Users who design applications for host controllers that use MECHATROLINK-II commands directly

Outline of Manual

The contents of the chapters of this manual are described in the following table.

Refer to these chapters as required.

Chapter	Chapter Title	Contents
1	Settings for MECHATROLINK-II Communications	Provides detailed information on MECHATROLINK-II communications.
2	Data Fields	Describes the common specifications for all commands and the command format.
3	Main Commands	Provides detailed information on the main commands.
4	Subcommands	Provides detailed information on the subcommands.
5	Operation Sequence	Describes basic operation sequences using MECHATROLINK-II communications.
6	Command Related Parameters	Describes the functions.
7	Detecting Alarms/Warnings Related to Communications or Commands	Describes the alarms and warnings that may occur in MECHATROLINK-II communications.
8	Appendices	Describes the brake control commands and the general-purpose servo control commands.

Related Documents

The relationships between the documents that are related to the Servo Drives are shown in the following figure. The numbers in the figure correspond to the numbers in the table on the following pages. Refer to these documents as required.

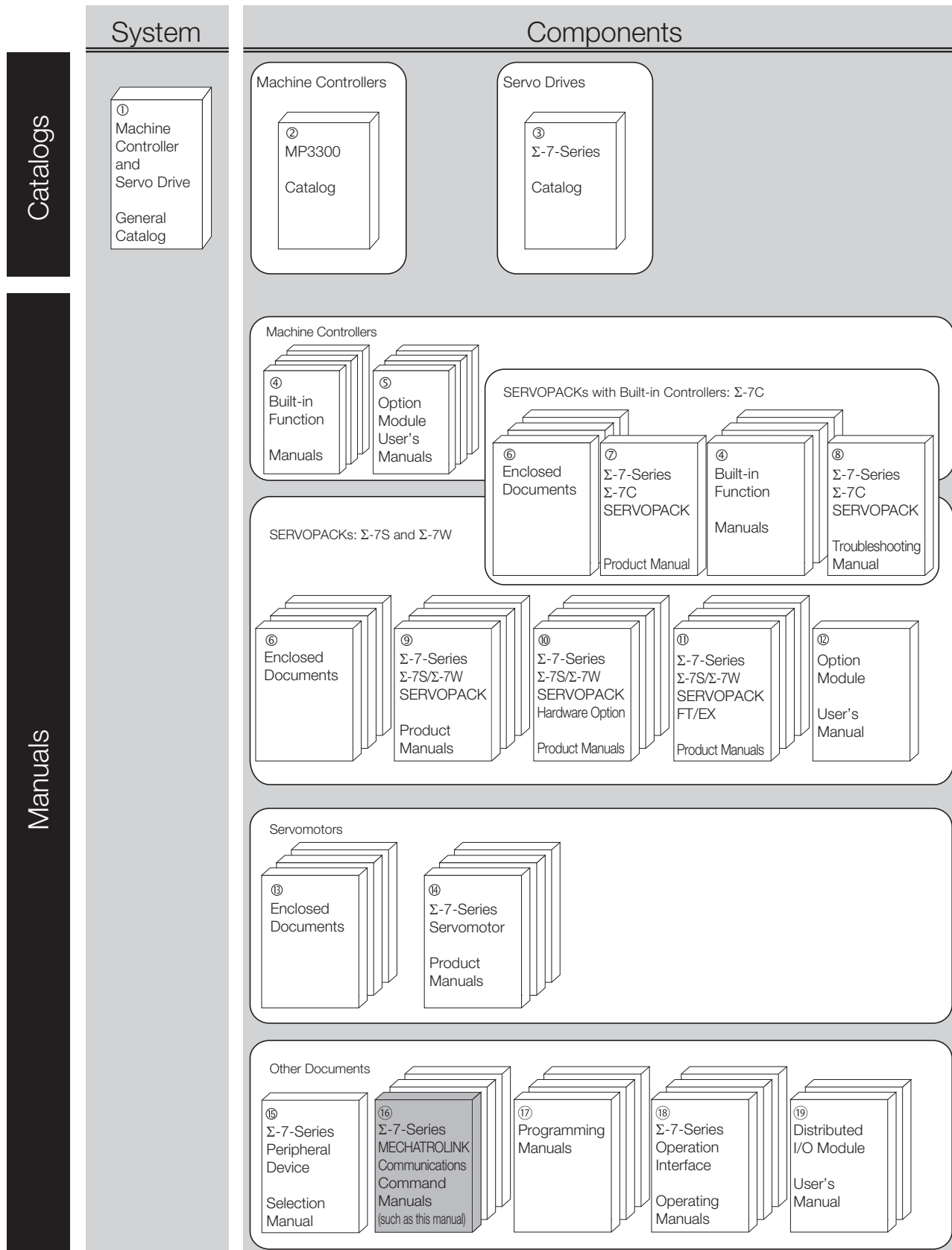

Classification	Document Name	Document No.	Description
① Machine Controller and Servo Drive General Catalog	Machine Controller and AC Servo Drive Solutions Catalog	KAEP S800001 22	Describes the features and application examples for combinations of MP3000-Series Machine Controllers and Σ -7-Series AC Servo Drives.
② MP3300 Catalog	Machine Controller MP3300	KAEP C880725 03	Provides detailed information on MP3300 Machine Controllers, including features and specifications.
③ Σ -7-Series Catalog	AC Servo Drives Σ -7 Series	KAEP S800001 23	Provides detailed information on Σ -7-Series AC Servo Drives, including features and specifications.
④ Built-in Function Manuals	Σ -7-Series AC Servo Drive Σ -7C SERVOPACK Motion Control User's Manual	SIEP S800002 03	Provides detailed information on the specifications, system configuration, and application methods of the Motion Control Function Modules (SVD, SVC4, and SVR4) for Σ -7-Series Σ -7C SERVOPACKs.
	Machine Controller MP3000 Series Communications User's Manual	SIEP C880725 12	Provides detailed information on the specifications, system configuration, and communications connection methods for the Ethernet communications that are used with MP3000-Series Machine Controllers and Σ -7-Series Σ -7C SERVOPACKs.
⑤ Option Module User's Manuals	Machine Controller MP2000 Series Communication Module User's Manual	SIEP C880700 04	Provide detailed information on the specifications and communications methods for the Communications Modules that can be mounted to MP3000-Series Machine Controllers and Σ -7-Series Σ -7C SERVOPACKs.
	Machine Controller MP2000 Series 262IF-01 FL-net Communication Module User's Manual	SIEP C880700 36	
	Machine Controller MP2000 Series 263IF-01 EtherNet/IP Communication Module User's Manual	SIEP C880700 39	
	Machine Controller MP2000 Series I/O Module User's Manual	SIEP C880700 34	Provide detailed information on the specifications and communications methods for the I/O Modules that can be mounted to MP3000-Series Machine Controllers and Σ -7-Series Σ -7C SERVOPACKs.
	Machine Controller MP2000 Series Analog Input/Analog Output Module AI-01/AO-01 User's Manual	SIEP C880700 26	
	Machine Controller MP2000 Series Counter Module CNTR-01 User's Manual	SIEP C880700 27	

Continued on next page.

Continued from previous page.

Classification	Document Name	Document No.	Description
⑥ Enclosed Documents	Σ-7-Series AC Servo Drive Σ-7S, Σ-7W, and Σ-7C SERVOPACK Safety Precautions	TOMP C710828 00	Provides detailed information for the safe usage of Σ-7-Series SERVOPACKS.
	Σ-V-Series/Σ-V-Series for Large-Capacity Models/ Σ-7-Series Safety Precautions Option Module	TOBP C720829 00	Provides detailed information for the safe usage of Option Modules.
	Σ-V-Series/Σ-V-Series for Large-Capacity Models/ Σ-7-Series Installation Guide Command Option Module	TOBP C720829 01	Provides detailed procedures for installing the Command Option Module in a SERVOPACK.
	Σ-V-Series/Σ-V-Series for Large-Capacity Models/ Σ-7-Series Installation Guide Fully-closed Module	TOBP C720829 03	Provides detailed procedures for installing the Fully-closed Module in a SERVOPACK.
	Σ-V-Series/Σ-V-Series for Large-Capacity Models/ Σ-7-Series Installation Guide Safety Module	TOBP C720829 06	Provides detailed procedures for installing the Safety Module in a SERVOPACK.
	Σ-V-Series/Σ-V-Series for Large-Capacity Models/ Σ-7-Series Installation Guide INDEXER Module	TOBP C720829 02	Provides detailed procedures for installing the INDEXER Module in a SERVOPACK.
	Σ-V-Series/Σ-V-Series for Large-Capacity Models/ Σ-7-Series Installation Guide DeviceNet Module	TOBP C720829 07	Provides detailed procedures for installing the DeviceNet Module in a SERVOPACK.
⑦ Σ-7-Series Σ-7C SERVOPACK Product Manual	Σ-7-Series AC Servo Drive Σ-7C SERVOPACK Product Manual	SIEP S800002 04	Provides detailed information on selecting Σ-7-Series Σ-7C SERVOPACKS; installing, connecting, setting, testing in trial operation, and tuning Servo Drives; writing, monitoring, and maintaining programs; and other information.
⑧ Σ-7-Series Σ-7C SERVOPACK Troubleshooting Manual	Σ-7-Series AC Servo Drive Σ-7C SERVOPACK Troubleshooting Manual	SIEP S800002 07	Provides detailed troubleshooting information for Σ-7-Series Σ-7C SERVOPACKS.

Continued on next page.

Continued from previous page.

Classification	Document Name	Document No.	Description
⑨ Σ-7-Series Σ-7S/Σ-7W SERVOPACK Product Manuals	Σ-7-Series AC Servo Drive Σ-7S SERVOPACK with MECHATROLINK-4 Communications References Product Manual	SIEP S800002 31	Provide detailed information on selecting Σ-7-Series SERVO-PACKs and information on installing, connecting, setting, performing trial operation for, tuning, monitoring, and maintaining the Servo Drives.
	Σ-7-Series AC Servo Drive Σ-7S SERVOPACK with MECHATROLINK-III Communications References Product Manual	SIEP S800001 28	
	Σ-7-Series AC Servo Drive Σ-7S SERVOPACK with MECHATROLINK-II Communications References Product Manual	SIEP S800001 27	
	Σ-7-Series AC Servo Drive Σ-7S SERVOPACK with Analog Voltage/Pulse Train References Product Manual	SIEP S800001 26	
	Σ-7-Series AC Servo Drive Σ-7S SERVOPACK Command Option Attachable Type with INDEXER Module Product Manual	SIEP S800001 64	
	Σ-7-Series AC Servo Drive Σ-7S SERVOPACK Command Option Attachable Type with DeviceNet Module Product Manual	SIEP S800001 70	
	Σ-7-Series AC Servo Drive Σ-7W SERVOPACK with MECHATROLINK-III Communications References Product Manual	SIEP S800001 29	
⑩ Σ-7-Series Σ-7S/Σ-7W SERVOPACK with Hardware Option Specifications Product Manuals	Σ-7-Series AC Servo Drive Σ-7S/Σ-7W SERVOPACK with Hardware Option Specifications Dynamic Brake Product Manual	SIEP S800001 73	Provide detailed information on Hardware Options for Σ-7-Series SERVOPACKs.
	Σ-7-Series AC Servo Drive Σ-7W/Σ-7C SERVOPACK with Hardware Option Specifications HWBB Function Product Manual	SIEP S800001 72	

Continued on next page.

Continued from previous page.

Classification	Document Name	Document No.	Description
⑩ Σ-7-Series Σ-7S/Σ-7W SERVOPACK FT/EX Product Manuals	Σ-7-Series AC Servo Drive Σ-7S SERVOPACK with FT/EX Specification for Indexing Application Product Manual	SIEP S800001 84	Provide detailed information on the FT/EX Option for Σ-7-Series SERVOPACKs.
	Σ-7-Series AC Servo Drive Σ-7S SERVOPACK with FT/EX Specification for Tracking Application Product Manual	SIEP S800001 89	
	Σ-7-Series AC Servo Drive Σ-7S SERVOPACK with FT/EX Specification for Application with Special Motor, SGM7D Motor Product Manual	SIEP S800001 91	
	Σ-7-Series AC Servo Drive Σ-7S SERVOPACK with FT/EX Specification for Press and Injection Molding Application Product Manual	SIEP S800001 94	
	Σ-7-Series AC Servo Drive Σ-7S SERVOPACK with FT/EX Specification for Transfer and Alignment Application Product Manual	SIEP S800001 95	
	Σ-7-Series AC Servo Drive Σ-7S SERVOPACK with FT/EX Specification for Torque/Force Assistance for Conveyance Application Product Manual	SIEP S800002 09	
	Σ-7-Series AC Servo Drive Σ-7S SERVOPACK with FT/EX Specification for Cutting Application Feed Shaft Motor Product Manual	SIEP S800002 10	
	Σ-7-Series AC Servo Drive Σ-7S SERVOPACK with FT/EX Specification for Three-Point Latching for Conveyance Application Product Manual	SIEP S800002 17	
	Σ-7-Series AC Servo Drive Σ-7S SERVOPACK with FT/EX Specification for Semi-/Fully-Closed Loop Control Online Switching for Conveyance Application Product Manual	SIEP S800002 27	
	Σ-7-Series AC Servo Drive Σ-7W SERVOPACK with FT/EX Specification for Gantry Applications Product Manual	SIEP S800002 29	

Continued on next page.

Continued from previous page.

Classification	Document Name	Document No.	Description
⑩ Option Module User's Manual	AC Servo Drives Σ -V Series/ Σ -V Series for Large-Capacity Models/ Σ -7 Series User's Manual Safety Module	SIEP C720829 06	Provides details information required for the design and main- tenance of a Safety Module.
⑩ Enclosed Documents	AC Servo Drive Rotary Servomotor Safety Precautions	TOBP C230260 00	Provides detailed information for the safe usage of Rotary Servo- motors and Direct Drive Servomo- tors.
	AC Servomotor Linear Σ Series Safety Precautions	TOBP C230800 00	Provides detailed information for the safe usage of Linear Servo- motors.
⑩ Σ -7-Series Servomotor Product Manuals	Σ -7-Series AC Servo Drive Rotary Servomotor Product Manual	SIEP S800001 36	Provide detailed information on selecting, installing, and connect- ing the Σ -7-Series Servomotors.
	Σ -7-Series AC Servo Drive Linear Servomotor Product Manual	SIEP S800001 37	
	Σ -7-Series AC Servo Drive Direct Drive Servomotor Product Manual	SIEP S800001 38	
⑩ Σ -7-Series Peripheral Device Selection Manual	Σ -7-Series AC Servo Drive Peripheral Device Selection Manual	SIEP S800001 32	Provides detailed information on the peripheral devices for a Σ -7- Series Servo System. <ul style="list-style-type: none"> • Cables: model, external dimen- sion, wiring materials, connector models, wiring specification • Peripheral devices: model, specification, dimensional draw- ing, selection (calculation) method
⑩ Σ -7-Series MECHATROLINK Communications Command Manuals	Σ -7-Series AC Servo Drive MECHATROLINK-II Communications Command Manual	This manual (SIEP S800001 30)	Provides detailed information on the MECHATROLINK-II communi- cations commands that are used for a Σ -7-Series Servo System.
	Σ -7-Series AC Servo Drive MECHATROLINK-III Communications Standard Servo Profile Command Manual	SIEP S800001 31	Provides detailed information on the MECHATROLINK-III commu- nications standard servo profile commands that are used for a Σ -7-Series Servo System.
	Σ -7-Series AC Servo Drive MECHATROLINK-4 Communications Standard Servo Profile Command Manual	SIEP S800002 32	Provides detailed information on the MECHATROLINK-4 communi- cations standard servo profile commands that are used for a Σ -7-Series Servo System.
⑩ Programming Manuals	Machine Controller MP3000 Series Ladder Programming Manual	SIEP C880725 13	Provides detailed information on the ladder programming specifi- cations and instructions for MP3000-Series Machine Control- lers and Σ -7-Series Σ -7C SERVO- PACKs.
	Machine Controller MP3000 Series Motion Programming Manual	SIEP C880725 14	Provides detailed information on the motion programming and sequence programming specifi- cations and instructions for MP3000-Series Machine Control- lers and Σ -7-Series Σ -7C SERVO- PACKs.

Continued on next page.

Continued from previous page.

Classification	Document Name	Document No.	Description
¹⁸ Σ-7-Series Operation Interface Operating Manuals	Machine Controller MP2000/MP3000 Series Engineering Tool MPE720 Version 7 User's Manual	SIEP C880761 03	Describes in detail how to operate MPE720 version 7.
	Σ-7-Series AC Servo Drive Digital Operator Operating Manual	SIEP S800001 33	Describes the operating procedures for a Digital Operator for a Σ-7-Series Servo System.
	AC Servo Drive Engineering Tool SigmaWin+ Operation Manual	SIET S800001 34	Provides detailed operating procedures for the SigmaWin+ Engineering Tool for a Σ-7-Series Servo System.
¹⁹ Distributed I/O Module User's Manual	MECHATROLINK-III Compatible I/O Module User's Manual	SIEP C880781 04	Describes the functions, specifications, operating methods, and MECHATROLINK-III communications for the Remote I/O Modules for MP2000/MP3000-Series Machine Controllers.
	MECHATROLINK-4 Compatible I/O Module User's Manual	SIEP C880782 01	Describes the functions, specifications, operating methods, and MECHATROLINK-4 communications for the Remote I/O Modules for MP3000-Series Machine Controllers.

Using This Manual

◆ Technical Terms Used in This Manual

The following terms are used in this manual.

Basic Term	Meaning
Transmission Cycle	The transmission cycle is the cycle in the MAC (Media Access Control) layer. It is the communication cycle for physically sending data to the transmission path. The transmission cycle is unaffected by the services provided by the application layer.
Communication Cycle	The communication cycle is the cycle for application layer. The communication cycle is set to an integral multiple of the transmission cycle.
Synchronous Commands (Classification S)	For commands of this type, commands are sent and response are received every communication cycle. The WDT (Watchdog Timer) in the frames are refreshed and checked every communication cycle. Synchronous commands can be used only during synchronous communications (Phase 3).
Asynchronous Commands (Classification A)	For commands of this type, commands are sent and response are received asynchronously to the communication cycle. Subsequent commands can be sent after confirming the completion of processing of the slave station that received the command. The WDT (Watchdog Timer) in the frames are not checked.
absolute encoder	The general term used for absolute encoders with batteries and batteryless absolute encoders. In cases where the general term causes confusion, the term "batteryless absolute encoder" may also be used.



Important

Be sure that you fully understand each command and use the commands in the order appropriate for your application.

Incorrect usage of the commands can result not only unexpected motions, but in a serious accident. Special care and verification must be taken for usage of the commands in order to avoid accidents. Be sure to also establish safety measures for the system.

This manual does not apply to users who use MP-series motion controllers for controlling Σ -7-Series SERVOPACKs.

◆ Differences in Terms for Rotary Servomotors and Linear Servomotors

There are differences in the terms that are used for Rotary Servomotors and Linear Servomotors. This manual primarily describes Rotary Servomotors. If you are using a Linear Servomotor, you need to interpret the terms as given in the following table.

Rotary Servomotors	Linear Servomotors
torque	force
moment of inertia	mass
rotation	movement
forward rotation and reverse rotation	forward movement and reverse movement
CW and CCW pulse trains	forward and reverse pulse trains
rotary encoder	linear encoder
absolute rotary encoder	absolute linear encoder
incremental rotary encoder	incremental linear encoder
unit: min^{-1}	unit: mm/s
unit: N·m	unit: N

◆ Notation Used in this Manual

■ Notation for Reverse Signals

The names of reverse signals (i.e., ones that are valid when low) are written with a forward slash (/) before the signal abbreviation.

Notation Example

\overline{BK} is written as /BK.

■ Notation for Parameters

The notation depends on whether the parameter requires a numeric setting (parameter for numeric setting) or requires the selection of a function (parameter for selecting functions).

• Parameters for Numeric Settings

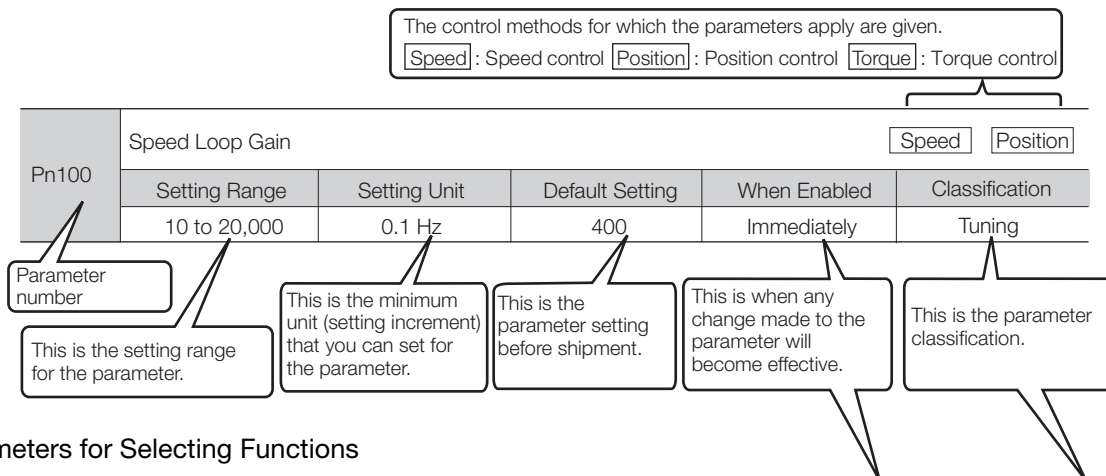

• Parameters for Selecting Functions

Parameter	Meaning	When Enabled	Classification
Pn002	n.□□□□ (default setting)	After startup	Setup
	n.□1□□		
	n.□2□□		

Parameter number: The notation "n.□□□□" indicates a parameter for selecting functions. Each □ indicates the setting for one digit. The notation shown here means that the third digit from the right is set to 2.

This column explains the selections for the function.

Notation Example

Notation Examples for Pn002

n . 0 0 0 0	Digit Notation		Numeric Value Notation	
	Notation	Meaning	Notation	Meaning
→	Pn002 = n.□□□X	Indicates the first digit from the right in Pn002.	Pn002 = n.□□□1	Indicates that the first digit from the right in Pn002 is set to 1.
→	Pn002 = n.□□X□	Indicates the second digit from the right in Pn002.	Pn002 = n.□□1□	Indicates that the second digit from the right in Pn002 is set to 1.
→	Pn002 = n.□X□□	Indicates the third digit from the right in Pn002.	Pn002 = n.□1□□	Indicates that the third digit from the right in Pn002 is set to 1.
→	Pn002 = n.X□□□	Indicates the fourth digit from the right in Pn002.	Pn002 = n.1□□□	Indicates that the fourth digit from the right in Pn002 is set to 1.

◆ Trademarks

- MECHATROLINK is a trademark of the MECHATROLINK Members Association.
- Other product names and company names are the trademarks or registered trademarks of the respective company. “TM” and the ® mark do not appear with product or company names in this manual.

◆ Visual Aids

The following aids are used to indicate certain types of information for easier reference.



Indicates precautions or restrictions that must be observed.
Also indicates alarm displays and other precautions that will not result in machine damage.



Indicates definitions of difficult terms or terms that have not been previously explained in this manual.

Example Indicates operating or setting examples.

Information Indicates supplemental information to deepen understanding or useful information.

Safety Precautions

◆ Safety Information

To prevent personal injury and equipment damage in advance, the following signal words are used to indicate safety precautions in this document. The signal words are used to classify the hazards and the degree of damage or injury that may occur if a product is used incorrectly. Information marked as shown below is important for safety. Always read this information and heed the precautions that are provided.



DANGER

- Indicates precautions that, if not heeded, are likely to result in loss of life, serious injury, or fire.



WARNING

- Indicates precautions that, if not heeded, could result in loss of life, serious injury, or fire.



CAUTION

- Indicates precautions that, if not heeded, could result in relatively serious or minor injury, or in fire.

NOTICE

- Indicates precautions that, if not heeded, could result in property damage.

◆ Safety Precautions That Must Always Be Observed

■ General Precautions



DANGER

- Read and understand this manual to ensure the safe usage of the product.
- Keep this manual in a safe, convenient place so that it can be referred to whenever necessary. Make sure that it is delivered to the final user of the product.
- Do not remove covers, cables, connectors, or optional devices while power is being supplied to the SERVOPACK.
There is a risk of electric shock, operational failure of the product, or burning.



WARNING

- Use a power supply with specifications (number of phases, voltage, frequency, and AC/DC type) that are appropriate for the product.
There is a risk of burning, electric shock, or fire.
- Connect the ground terminals on the SERVOPACK and Servomotor to ground poles according to local electrical codes (100 Ω or less for a SERVOPACK with a 100-VAC or 200-VAC power supply, and 10 Ω or less for a SERVOPACK with a 400-VAC power supply).
There is a risk of electric shock or fire.
- Do not attempt to disassemble, repair, or modify the product.
There is a risk of fire or failure.
The warranty is void for the product if you disassemble, repair, or modify it.



CAUTION

- The SERVOPACK heat sinks, regenerative resistors, External Dynamic Brake Resistors, Servomotors, and other components can be very hot while power is ON or soon after the power is turned OFF. Implement safety measures, such as installing covers, so that hands and parts such as cables do not come into contact with hot components.
There is a risk of burn injury.
- For a 24-VDC power supply, use a power supply device with double insulation or reinforced insulation.
There is a risk of electric shock.
- Do not damage, pull on, apply excessive force to, place heavy objects on, or pinch cables.
There is a risk of failure, damage, or electric shock.
- The person who designs the system that uses the hard wire base block safety function must have a complete knowledge of the related safety standards and a complete understanding of the instructions in this document.
There is a risk of injury, product damage, or machine damage.
- Do not use the product in an environment that is subject to water, corrosive gases, or flammable gases, or near flammable materials.
There is a risk of electric shock or fire.

NOTICE

- Do not attempt to use a SERVOPACK or Servomotor that is damaged or that has missing parts.
- Install external emergency stop circuits that shut OFF the power supply and stops operation immediately when an error occurs.
- In locations with poor power supply conditions, install the necessary protective devices (such as AC reactors) to ensure that the input power is supplied within the specified voltage range. There is a risk of damage to the SERVOPACK.
- Use a Noise Filter to minimize the effects of electromagnetic interference. Electronic devices used near the SERVOPACK may be affected by electromagnetic interference.
- Always use a Servomotor and SERVOPACK in one of the specified combinations.
- Do not touch a SERVOPACK or Servomotor with wet hands. There is a risk of product failure.

■ Storage Precautions



CAUTION

- Do not place an excessive load on the product during storage. (Follow all instructions on the packages.) There is a risk of injury or damage.

NOTICE

- Do not install or store the product in any of the following locations.
 - Locations that are subject to direct sunlight
 - Locations that are subject to ambient temperatures that exceed product specifications
 - Locations that are subject to relative humidities that exceed product specifications
 - Locations that are subject to condensation as the result of extreme changes in temperature
 - Locations that are subject to corrosive or flammable gases
 - Locations that are near flammable materials
 - Locations that are subject to dust, salts, or iron powder
 - Locations that are subject to water, oil, or chemicals
 - Locations that are subject to vibration or shock that exceeds product specifications
 - Locations that are subject to radiation
- If you store or install the product in any of the above locations, the product may fail or be damaged.

■ Transportation Precautions



CAUTION

- Transport the product in a way that is suitable to the mass of the product.
- Do not use the eyebolts on a SERVOPACK or Servomotor to move the machine. There is a risk of damage or injury.
- When you handle a SERVOPACK or Servomotor, be careful of sharp parts, such as the corners. There is a risk of injury.
- Do not place an excessive load on the product during transportation. (Follow all instructions on the packages.) There is a risk of injury or damage.

NOTICE

- **Do not hold onto the front cover or connectors when you move a SERVOPACK.**
There is a risk of the SERVOPACK falling.
- **A SERVOPACK or Servomotor is a precision device. Do not drop it or subject it to strong shock.**
There is a risk of failure or damage.
- **Do not subject connectors to shock.**
There is a risk of faulty connections or damage.
- **If disinfectants or insecticides must be used to treat packing materials such as wooden frames, plywood, or pallets, the packing materials must be treated before the product is packaged, and methods other than fumigation must be used.**
Example: Heat treatment, where materials are kiln-dried to a core temperature of 56°C for 30 minutes or more.
If the electronic products, which include stand-alone products and products installed in machines, are packed with fumigated wooden materials, the electrical components may be greatly damaged by the gases or fumes resulting from the fumigation process. In particular, disinfectants containing halogen, which includes chlorine, fluorine, bromine, or iodine can contribute to the erosion of the capacitors.
- **Do not overtighten the eyebolts on a SERVOPACK or Servomotor.**
If you use a tool to overtighten the eyebolts, the tapped holes may be damaged.

■ Installation Precautions



CAUTION

- **Install the Servomotor or SERVOPACK in a way that will support the mass given in technical documents.**
- **Install SERVOPACKs, Servomotors, regenerative resistors, and External Dynamic Brake Resistors on nonflammable materials.**
Installation directly onto or near flammable materials may result in fire.
- **Provide the specified clearances between the SERVOPACK and the control panel as well as with other devices.**
There is a risk of fire or failure.
- **Install the SERVOPACK in the specified orientation.**
There is a risk of fire or failure.
- **Do not step on or place a heavy object on the product.**
There is a risk of failure, damage, or injury.
- **Do not allow any foreign matter to enter the SERVOPACK or Servomotor.**
There is a risk of failure or fire.

NOTICE

- **Do not install or store the product in any of the following locations.**
 - Locations that are subject to direct sunlight
 - Locations that are subject to ambient temperatures that exceed product specifications
 - Locations that are subject to relative humidities that exceed product specifications
 - Locations that are subject to condensation as the result of extreme changes in temperature
 - Locations that are subject to corrosive or flammable gases
 - Locations that are near flammable materials
 - Locations that are subject to dust, salts, or iron powder
 - Locations that are subject to water, oil, or chemicals
 - Locations that are subject to vibration or shock that exceeds product specifications
 - Locations that are subject to radiationIf you store or install the product in any of the above locations, the product may fail or be damaged.
- **Use the product in an environment that is appropriate for the product specifications.**

If you use the product in an environment that exceeds product specifications, the product may fail or be damaged.
- **A SERVOPACK or Servomotor is a precision device. Do not drop it or subject it to strong shock.**

There is a risk of failure or damage.
- **Always install a SERVOPACK in a control panel.**
- **Do not allow any foreign matter to enter a SERVOPACK or a Servomotor with a Cooling Fan and do not cover the outlet from the Servomotor's cooling fan.**

There is a risk of failure.

■ Wiring Precautions



DANGER

- **Do not change any wiring while power is being supplied.**

There is a risk of electric shock or injury.



WARNING

- **Wiring and inspections must be performed only by qualified engineers.**

There is a risk of electric shock or product failure.
- **Check all wiring and power supplies carefully.**

Incorrect wiring or incorrect voltage application to the output circuits may cause short-circuit failures. If a short-circuit failure occurs as a result of any of these causes, the holding brake will not work. This could damage the machine or cause an accident that may result in death or injury.
- **Connect the AC and DC power supplies to the specified SERVOPACK terminals.**
 - Connect an AC power supply to the L1, L2, and L3 terminals and the L1C and L2C terminals on the SERVOPACK.
 - Connect a DC power supply to the B1/⊕ and ⊖2 terminals and the L1C and L2C terminals on the SERVOPACK.

There is a risk of failure or fire.
- **If you use a SERVOPACK with the Dynamic Brake Hardware Option, connect an External Dynamic Brake Resistor that is suitable for the machine and equipment specifications to the specified terminals.**

There is a risk of unexpected operation, machine damage, burning, or injury when an emergency stop is performed.



CAUTION

- Wait for at least six minutes after turning OFF the power supply (with a SERVOPACK for a 100-VAC power supply input, wait for at least nine minutes) and then make sure that the CHARGE indicator is not lit before starting wiring or inspection work. Do not touch the power supply terminals while the CHARGE lamp is lit because high voltage may still remain in the SERVOPACK even after turning OFF the power supply.
There is a risk of electric shock.
- Observe the precautions and instructions for wiring and trial operation precisely as described in this document.
Failures caused by incorrect wiring or incorrect voltage application in the brake circuit may cause the SERVOPACK to fail, damage the equipment, or cause an accident resulting in death or injury.
- Check the wiring to be sure it has been performed correctly.
Connectors and pin layouts are sometimes different for different models. Always confirm the pin layouts in technical documents for your model before operation.
There is a risk of failure or malfunction.
- Connect wires to power supply terminals and motor connection terminals securely with the specified methods and tightening torque.
Insufficient tightening may cause wires and terminal blocks to generate heat due to faulty contact, possibly resulting in fire.
- Use shielded twisted-pair cables or screened unshielded multi-twisted-pair cables for I/O Signal Cables and Encoder Cables.
- The maximum wiring length is 3 m for I/O Signal Cables, and 50 m for Encoder Cables or Servomotor Main Circuit Cables.
- Observe the following precautions when wiring the SERVOPACK's main circuit terminals.
 - Turn ON the power supply to the SERVOPACK only after all wiring, including the main circuit terminals, has been completed.
 - If a connector is used for the main circuit terminals, remove the main circuit connector from the SERVOPACK before you wire it.
 - Insert only one wire per insertion hole in the main circuit terminals.
 - When you insert a wire, make sure that the conductor wire (e.g., whiskers) does not come into contact with adjacent wires and cause a short-circuit.
- Install molded-case circuit breakers and other safety measures to provide protection against short circuits in external wiring.
There is a risk of fire or failure.

NOTICE

- Whenever possible, use the Cables specified by Yaskawa.
If you use any other cables, confirm the rated current and application environment of your model and use the wiring materials specified by Yaskawa or equivalent materials.
- Securely tighten connector screws and lock mechanisms.
Insufficient tightening may result in connectors falling off during operation.
- Do not bundle power lines (e.g., the Main Circuit Cable) and low-current lines (e.g., the I/O Signal Cables or Encoder Cables) together or run them through the same duct. If you do not place power lines and low-current lines in separate ducts, separate them by at least 30 cm.
If the cables are too close to each other, malfunctions may occur due to noise affecting the low-current lines.
- Install a battery at either the host controller or on the Encoder Cable.
If you install batteries both at the host controller and on the Encoder Cable at the same time, you will create a loop circuit between the batteries, resulting in a risk of damage or burning.
- When connecting a battery, connect the polarity correctly.
There is a risk of battery rupture or encoder failure.

■ Operation Precautions



WARNING

- Before starting operation with a machine connected, change the settings of the switches and parameters to match the machine.
Unexpected machine operation, failure, or personal injury may occur if operation is started before appropriate settings are made.
- Do not radically change the settings of the parameters.
There is a risk of unstable operation, machine damage, or injury.
- Install limit switches or stoppers at the ends of the moving parts of the machine to prevent unexpected accidents.
There is a risk of machine damage or injury.
- For trial operation, securely mount the Servomotor and disconnect it from the machine.
There is a risk of injury.
- Forcing the motor to stop for overtravel is disabled when the Jog, Origin Search, or Easy FFT utility function is executed. Take necessary precautions.
There is a risk of machine damage or injury.
- When an alarm occurs, the Servomotor will coast to a stop or stop with the dynamic brake according to the SERVOPACK Option and settings. The coasting distance will change with the moment of inertia of the load and the resistance of the External Dynamic Brake Resistor. Check the coasting distance during trial operation and implement suitable safety measures on the machine.
- Do not enter the machine's range of motion during operation.
There is a risk of injury.
- Do not touch the moving parts of the Servomotor or machine during operation.
There is a risk of injury.



CAUTION

- Design the system to ensure safety even when problems, such as broken signal lines, occur. For example, the P-OT and N-OT signals are set in the default settings to operate on the safe side if a signal line breaks. Do not change the polarity of this type of signal.
- When overtravel occurs, the power supply to the motor is turned OFF and the brake is released. If you use the Servomotor to drive a vertical load, set the Servomotor to enter a zero-clamped state after the Servomotor stops. Also, install safety devices (such as an external brake or counterweight) to prevent the moving parts of the machine from falling.
- Always turn OFF the servo before you turn OFF the power supply. If you turn OFF the main circuit power supply or control power supply during operation before you turn OFF the servo, the Servomotor will stop as follows:
 - If you turn OFF the main circuit power supply during operation without turning OFF the servo, the Servomotor will stop abruptly with the dynamic brake.
 - If you turn OFF the control power supply without turning OFF the servo, the stopping method that is used by the Servomotor depends on the model of the SERVOPACK. For details, refer to the manual for the SERVOPACK.
 - If you use a SERVOPACK with the Dynamic Brake Hardware Option, the Servomotor stopping methods will be different from the stopping methods used without the Option or with other Hardware Options. For details, refer to the following manual.
 Σ -7-Series Σ -7S/ Σ -7W SERVOPACK with Dynamic Brake Hardware Option Specifications Product Manual (Manual No.: SIEP S800001 73)
- Do not use the dynamic brake for any application other than an emergency stop.
There is a risk of failure due to rapid deterioration of elements in the SERVOPACK and the risk of unexpected operation, machine damage, burning, or injury.

NOTICE

- When you adjust the gain during system commissioning, use a measuring instrument to monitor the torque waveform and speed waveform and confirm that there is no vibration.
If a high gain causes vibration, the Servomotor will be damaged quickly.
- Do not frequently turn the power supply ON and OFF. After you have started actual operation, allow at least one hour between turning the power supply ON and OFF (as a guideline).
Do not use the product in applications that require the power supply to be turned ON and OFF frequently.
The elements in the SERVOPACK will deteriorate quickly.
- An alarm or warning may occur if communications are performed with the host controller while the SigmaWin+ or Digital Operator is operating.
If an alarm or warning occurs, it may interrupt the current process and stop the system.
- After you complete trial operation of the machine and facilities, use the SigmaWin+ to back up the settings of the SERVOPACK parameters. You can use them to reset the parameters after SERVOPACK replacement.
If you do not copy backed up parameter settings, normal operation may not be possible after a faulty SERVOPACK is replaced, possibly resulting in machine or equipment damage.

■ Maintenance and Inspection Precautions



DANGER

- Do not change any wiring while power is being supplied.
There is a risk of electric shock or injury.



WARNING

- Wiring and inspections must be performed only by qualified engineers.
There is a risk of electric shock or product failure.



CAUTION

- Wait for at least six minutes after turning OFF the power supply (with a SERVOPACK for a 100-VAC power supply input, wait for at least nine minutes) and then make sure that the CHARGE indicator is not lit before starting wiring or inspection work. Do not touch the power supply terminals while the CHARGE lamp is lit because high voltage may still remain in the SERVOPACK even after turning OFF the power supply.
There is a risk of electric shock.
- Before you replace a SERVOPACK, back up the settings of the SERVOPACK parameters. Copy the backed up parameter settings to the new SERVOPACK and confirm that they were copied correctly.
If you do not copy backed up parameter settings or if the copy operation is not completed correctly, normal operation may not be possible, possibly resulting in machine or equipment damage.

NOTICE

- Discharge all static electricity from your body before you operate any of the buttons or switches inside the front cover of the SERVOPACK.
There is a risk of equipment damage.

■ Troubleshooting Precautions



DANGER

- If the safety device (molded-case circuit breaker or fuse) installed in the power supply line operates, remove the cause before you supply power to the SERVOPACK again. If necessary, repair or replace the SERVOPACK, check the wiring, and remove the factor that caused the safety device to operate.
There is a risk of fire, electric shock, or injury.



WARNING

- The product may suddenly start to operate when the power supply is recovered after a momentary power interruption. Design the machine to ensure human safety when operation restarts.
There is a risk of injury.



CAUTION

- When an alarm occurs, remove the cause of the alarm and ensure safety. Then reset the alarm or turn the power supply OFF and ON again to restart operation.
There is a risk of injury or machine damage.
- If the Servo ON signal is input to the SERVOPACK and an alarm is reset, the Servomotor may suddenly restart operation. Confirm that the servo is OFF and ensure safety before you reset an alarm.
There is a risk of injury or machine damage.
- Always insert a magnetic contactor in the line between the main circuit power supply and the main circuit power supply terminals on the SERVOPACK so that the power supply can be shut OFF at the main circuit power supply.
If a magnetic contactor is not connected when the SERVOPACK fails, a large current may flow continuously, possibly resulting in fire.
- If an alarm occurs, shut OFF the main circuit power supply.
There is a risk of fire due to a regenerative resistor overheating as the result of regenerative transistor failure.
- Install a ground fault detector against overloads and short-circuiting or install a molded-case circuit breaker combined with a ground fault detector.
There is a risk of SERVOPACK failure or fire if a ground fault occurs.
- The holding brake on a Servomotor will not ensure safety if there is the possibility that an external force (including gravity) may move the current position and create a hazardous situation when power is interrupted or an error occurs. If an external force may cause movement, install an external braking mechanism that ensures safety.

■ General Precautions

- Figures provided in this manual are typical examples or conceptual representations. There may be differences between them and actual wiring, circuits, and products.
- The products shown in illustrations in this manual are sometimes shown with their covers or protective guards removed to illustrate detail. Always replace all covers and protective guards before you use the product.
- If you need a new copy of this manual because it has been lost or damaged, contact your nearest Yaskawa representative or one of the offices listed on the back of this manual.
- This manual is subject to change without notice for product improvements, specifications changes, and improvements to the manual itself.
We will update the manual number of the manual and issue revisions when changes are made.
- Any and all quality guarantees provided by Yaskawa are null and void if the customer modifies the product in any way. Yaskawa disavows any responsibility for damages or losses that are caused by modified products.

Warranty

◆ Details of Warranty

■ Warranty Period

The warranty period for a product that was purchased (hereinafter called the “delivered product”) is one year from the time of delivery to the location specified by the customer or 18 months from the time of shipment from the Yaskawa factory, whichever is sooner.

■ Warranty Scope

Yaskawa shall replace or repair a defective product free of charge if a defect attributable to Yaskawa occurs during the above warranty period.

This warranty does not cover defects caused by the delivered product reaching the end of its service life and replacement of parts that require replacement or that have a limited service life.

This warranty does not cover failures that result from any of the following causes.

- Improper handling, abuse, or use in unsuitable conditions or in environments not described in product catalogs or manuals, or in any separately agreed-upon specifications
- Causes not attributable to the delivered product itself
- Modifications or repairs not performed by Yaskawa
- Use of the delivered product in a manner in which it was not originally intended
- Causes that were not foreseeable with the scientific and technological understanding at the time of shipment from Yaskawa
- Events for which Yaskawa is not responsible, such as natural or human-made disasters

◆ Limitations of Liability

- Yaskawa shall in no event be responsible for any damage or loss of opportunity to the customer that arises due to failure of the delivered product.
- Yaskawa shall not be responsible for any programs (including parameter settings) or the results of program execution of the programs provided by the user or by a third party for use with programmable Yaskawa products.
- The information described in product catalogs or manuals is provided for the purpose of the customer purchasing the appropriate product for the intended application. The use thereof does not guarantee that there are no infringements of intellectual property rights or other proprietary rights of Yaskawa or third parties, nor does it construe a license.
- Yaskawa shall not be responsible for any damage arising from infringements of intellectual property rights or other proprietary rights of third parties as a result of using the information described in catalogs or manuals.

◆ Suitability for Use

- It is the customer's responsibility to confirm conformity with any standards, codes, or regulations that apply if the Yaskawa product is used in combination with any other products.
- The customer must confirm that the Yaskawa product is suitable for the systems, machines, and equipment used by the customer.
- Consult with Yaskawa to determine whether use in the following applications is acceptable. If use in the application is acceptable, use the product with extra allowance in ratings and specifications, and provide safety measures to minimize hazards in the event of failure.
 - Outdoor use, use involving potential chemical contamination or electrical interference, or use in conditions or environments not described in product catalogs or manuals
 - Nuclear energy control systems, combustion systems, railroad systems, aviation systems, vehicle systems, medical equipment, amusement machines, and installations subject to separate industry or government regulations
 - Systems, machines, and equipment that may present a risk to life or property
 - Systems that require a high degree of reliability, such as systems that supply gas, water, or electricity, or systems that operate continuously 24 hours a day
 - Other systems that require a similar high degree of safety
- Never use the product for an application involving serious risk to life or property without first ensuring that the system is designed to secure the required level of safety with risk warnings and redundancy, and that the Yaskawa product is properly rated and installed.
- The circuit examples and other application examples described in product catalogs and manuals are for reference. Check the functionality and safety of the actual devices and equipment to be used before using the product.
- Read and understand all use prohibitions and precautions, and operate the Yaskawa product correctly to prevent accidental harm to third parties.

◆ Specifications Change

The names, specifications, appearance, and accessories of products in product catalogs and manuals may be changed at any time based on improvements and other reasons. The next editions of the revised catalogs or manuals will be published with updated code numbers. Consult with your Yaskawa representative to confirm the actual specifications before purchasing a product.

Contents

About this Manual	iii
Outline of Manual	iii
Related Documents	iv
Using This Manual	xi
Safety Precautions	xiv
Warranty	xxiii

1

Settings for MECHATROLINK-II Communications

1.1	MECHATROLINK-II Communications	1-2
1.1.1	Layers	1-2
1.1.2	Frame Structure	1-2
1.1.3	State Transition Diagram	1-3
1.2	Command and Response Timing	1-4
1.2.1	Command Data Execution Timing	1-4
1.2.2	Monitored Data Input Timing	1-4
1.3	Data Order	1-5
1.4	MECHATROLINK-II Command List.	1-6
1.4.1	Main Commands (In command code order)	1-6
1.4.2	Subcommands (In command code order)	1-7
1.4.3	Combination of MECHATROLINK-II Main Commands and Subcommands	1-8

2

Data Field

2.1	Main Command Data Field	2-2
2.1.1	Status Field Specifications	2-2
2.1.2	OPTION Field Specifications	2-3
2.1.3	Monitor Selection Field Specifications: SEL_MON1/2/3/4	2-4
2.1.4	Monitor Information Field Specifications: MONITOR 1/2/3/4	2-5
2.1.5	IO Monitor Field Specifications: IO_MON	2-6
2.1.6	LT_SGNL Specifications	2-7
2.2	Substatus Data Field	2-8
2.2.1	Substatus Field Specification	2-8
2.2.2	Extension Status Field Specifications	2-8

3

Main Commands

3.1	Commands Used to Prepare for Operation	3-3
3.1.1	NOP (No Operation) Command: 00 Hex	3-3
3.1.2	DISCONNECT (Release Connection) Command: 0F Hex	3-5
3.1.3	CONNECT (Establish MECHATROLINK-II Connection) Command: 0E Hex	3-6
3.1.4	SYNC_SET (Start Synchronous Communications) Command: 0D Hex	3-8

3.1.5	ID_RD (Check Device ID) Command: 03 Hex	3-9
3.1.6	PRM_WR (Set Parameter) Command: 02 Hex	3-11
3.1.7	PPRM_WR (Set and Save Parameters in Non-volatile Memory) Command: 1C Hex	3-12
3.1.8	CONFIG (Enable Parameters) Command: 04 Hex	3-13
3.1.9	SENS_ON (Turn ON Encoder Power Supply) Command: 23 Hex	3-14
3.1.10	SV_ON (Turn ON Servo) Command: 31 Hex	3-15
3.1.11	SENS_OFF (Turn OFF Encoder Power Supply) Command: 24 Hex	3-16
3.1.12	SV_OFF (Turn Servo OFF) Command: 32 Hex	3-17
3.1.13	PRM_RD (Read Parameter) Command: 01 Hex	3-18
3.1.14	SMON (Check SERVOPACK Status) Command: 30 Hex	3-19
3.1.15	ALM_RD (Read Alarm or Warning) Command: 05 Hex	3-20
3.1.16	ALM_CLR (Clear Warnings and Alarms) Command: 06 Hex	3-22
3.1.17	POS_SET (Set Coordinate System) Command: 20 Hex	3-23
3.1.18	ADJ (Monitor and Adjust Settings) Command: 3E Hex	3-24

3.2 Motion Commands 3-28

3.2.1	HOLD (Stop Motion) Command: 25 Hex	3-28
3.2.2	LTMOD_ON (Set Latch Mode) Command: 28 Hex	3-30
3.2.3	LTMOD_OFF (Release Latch Mode) Command: 29 Hex	3-33
3.2.4	INTERPOLATE (Interpolation Feeding) Command: 34 Hex	3-34
3.2.5	POSING (Positioning) Command: 35 Hex	3-36
3.2.6	FEED (Constant Speed Feeding) Command: 36 Hex	3-38
3.2.7	LATCH (Interpolation Feeding with Position Detection) Command: 38 Hex	3-40
3.2.8	EX_POSING (External Input Positioning) Command: 39 Hex	3-42
3.2.9	ZRET (Origin Return) Command: 3A Hex	3-44
3.2.10	VELCTRL (Velocity Control) Command: 3C Hex	3-46
3.2.11	TRQCTRL (Torque Control) Command: 3D Hex	3-48
3.2.12	Restrictions in Using Servo Commands	3-50

4

Subcommands

4.1 MECHATROLINK-II Subcommands List 4-2

4.2 MECHATROLINK-II Subcommands Details 4-3

4.2.1	NOP (No Operation) Command: 00 Hex	4-3
4.2.2	PRM_RD (Read Parameter) Command: 01 Hex	4-3
4.2.3	PRM_WR (Write Parameter) Command: 02 Hex	4-4
4.2.4	ALM_RD (Read Alarm or Warning) Command: 05 Hex	4-4
4.2.5	PPRM_WR (Write Non-volatile Parameter) Command: 1C Hex	4-5
4.2.6	LTMOD_ON (Set Latch Mode) Command: 28 Hex	4-5
4.2.7	LTMOD_OFF (Release Latch Mode) Command: 29 Hex	4-6
4.2.8	SMON (Status Monitoring) Command: 30 Hex	4-6

5

Operation Sequence

5.1 Preparing for Operation 5-2

5.1.1	Setting MECHATROLINK-II Communications	5-2
5.1.2	Checking the Communications Status	5-4

5.2 Operation Sequence for Managing Parameters Using a Controller . . 5-5

5.3	Operation Sequence for Managing Parameters Using a SERVOPACK . . .	5-6
5.3.1	Setup Sequence	5-6
5.3.2	Ordinary Operation Sequence	5-6
5.4	Specific Operation Sequences.	5-7
5.4.1	Operation Sequence When Turning the Servo ON	5-7
5.4.2	Operation Sequence When OT (Overtravel Limit Switch) Signal Is Input . . .	5-7
5.4.3	Operation Sequence at Emergency Stop (Main Circuit OFF)	5-8
5.4.4	Operation Sequence When a Safety Signal is Input	5-8
5.4.5	Operation Sequence at Occurrence of Alarm	5-9
5.4.6	When Motion Command Is Interrupted and Servomotor Is in Position	5-9
5.5	Setting the Origin Before Starting Operation	5-10
5.5.1	When Using an Incremental Encoder	5-10
5.5.2	When Using an Absolute Encoder	5-10

6 Command Related Parameters

6.1	Command Related Parameters List	6-2
6.2	Command Related Parameters Details	6-4
6.2.1	Electronic Gear Settings	6-4
6.2.2	Motion Acceleration/Deceleration Function Setting	6-10
6.2.3	Motion Sequence Setting	6-14
6.2.4	Command Data Options	6-15
6.2.5	Position Data Latch Function Setting	6-21
6.2.6	Settings for Acceleration/Deceleration Parameter High-speed Switching	6-24
6.2.7	STATUS Field and Monitor Related Settings	6-27

7 Detecting Alarms/Warnings Related to Communications or Commands

7.1	List of Alarms	7-2
7.2	List of Warnings	7-5
7.3	Monitoring Communication Data on Occurrence of an Alarm or Warning . .	7-7

8 Appendix

8.1	Brake Control Commands	8-2
8.2	General-purpose Servo Control Command	8-6

Revision History

Settings for MECHATROLINK-II Communications

1

This chapter outlines the settings that are required for MECHATROLINK-II communications.

1.1	MECHATROLINK-II Communications	1-2
1.1.1	Layers	1-2
1.1.2	Frame Structure	1-2
1.1.3	State Transition Diagram	1-3
1.2	Command and Response Timing	1-4
1.2.1	Command Data Execution Timing	1-4
1.2.2	Monitored Data Input Timing	1-4
1.3	Data Order	1-5
1.4	MECHATROLINK-II Command List	1-6
1.4.1	Main Commands (In command code order)	1-6
1.4.2	Subcommands (In command code order)	1-7
1.4.3	Combination of MECHATROLINK-II Main Commands and Subcommands	1-8

1.1 MECHATROLINK-II Communications

1.1.1 Layers

The MECHATROLINK-II communications layers have functions equivalent to layers 1, 2, and 7 in the OSI (Open System Interconnection) reference model.

OSI Reference Model and MECHATROLINK-II Model

OSI	MECHATROLINK-II
Layer 7: Application layer	MECHATROLINK-II application layer
Layers 3 to 6	None
Layer 2: Data link layer	MECHATROLINK-II data link layer
Layer 1: Physical layer	MECHATROLINK-II physical layer

This manual describes commands for the application layer.

1.1.2 Frame Structure

A MECHATROLINK-II command is composed of a main command and a subcommand as shown below. It can also be used only with a main command.

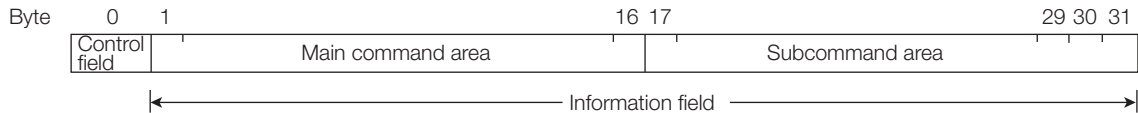

Classification	Byte	Command	Response
Control Field	0	03 hex (Fixed)	01 hex (Fixed)
Information Field	1 to 16	Used by main command.	
	17 to 31	Used by subcommands. The subcommands for servo drives use only 17th to 29th byte. Therefore, only 17th to 29th byte are described in this manual. Note: In some main commands, subcommand cannot be used.	

The application layer interfaces with only the information field.

1.1.3 State Transition Diagram

The primary (master) and secondary (slave) station state transitions are shown in the following diagrams.

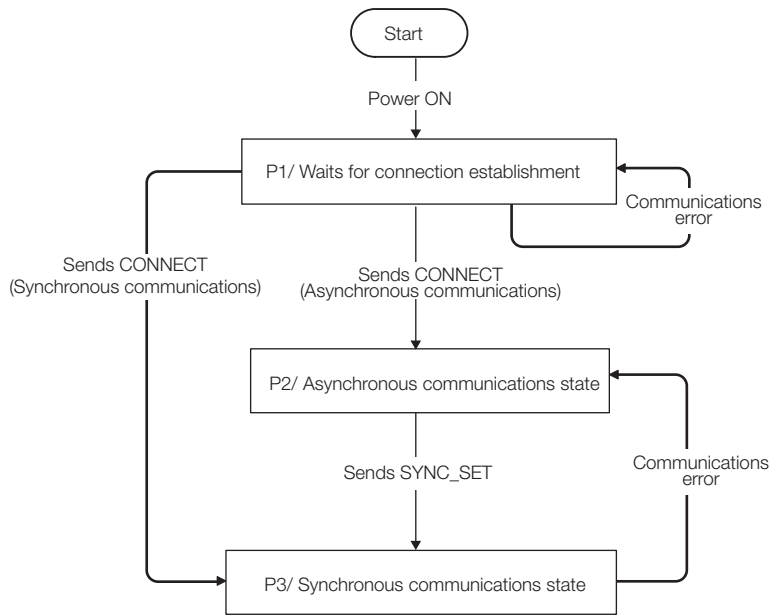

Primary Station (Master Station) State Transition

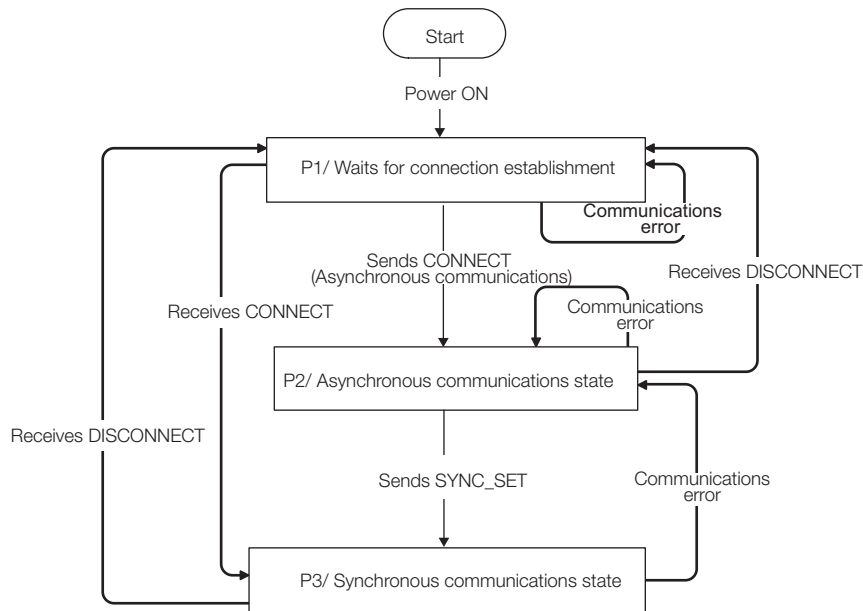

Secondary Station (Slave Station) State Transition

Phase	Abbreviation	Description
1	P1	Waiting for establishment of connection.
2	P2	Asynchronous communications enabled. Only asynchronous commands can be used.
3	P3	Synchronous communications enabled. Both synchronous and asynchronous commands can be used.

1.2 Command and Response Timing

This section describes command execution timing at a slave station and monitored data input timing at the master station.

These timings are constant, regardless of the transmission cycle and communications cycle.

1.2.1 Command Data Execution Timing

Motion commands (such as POSING and INTERPOLATE) and the OPTION in the command data field are executed 125 μ s after they are received.

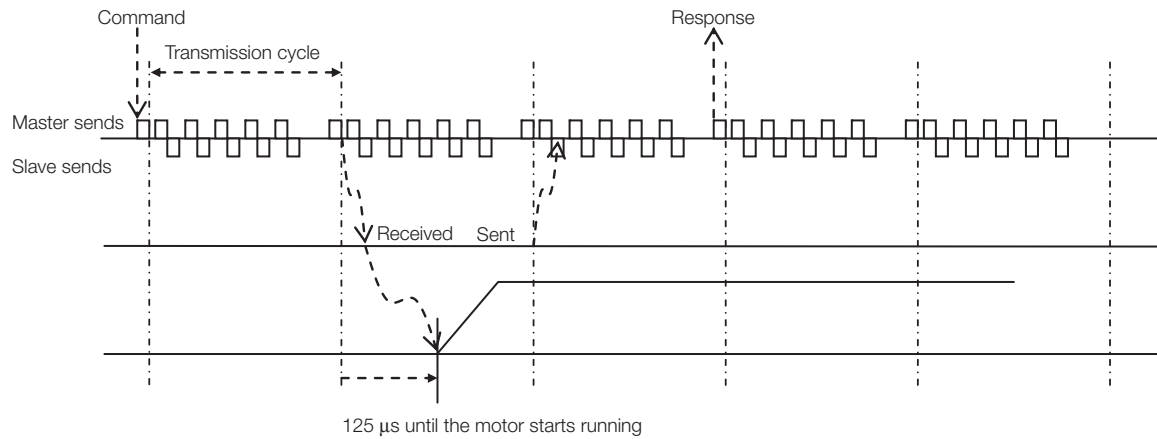

1.2.2 Monitored Data Input Timing

The monitor, I/O, and status data are the data of 125 μ s before the response is sent.

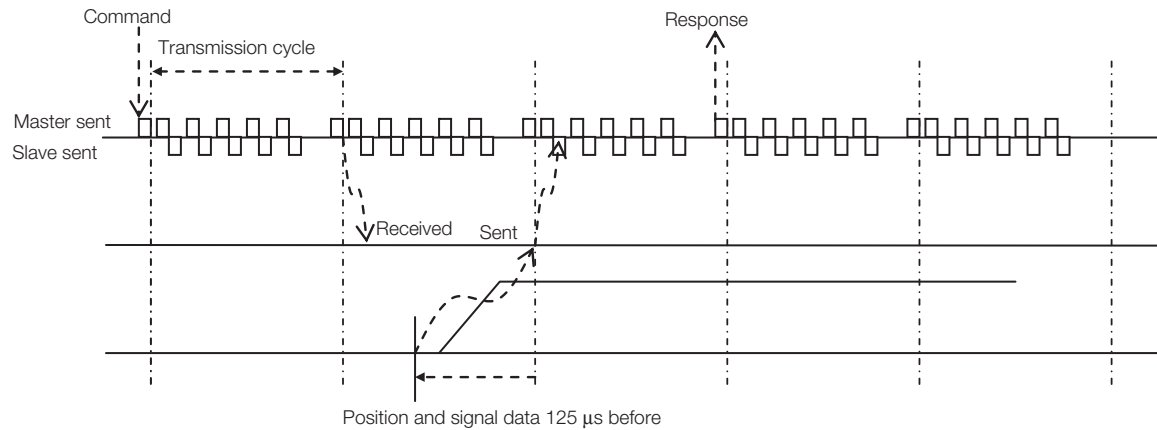

1.3 Data Order

Data in MECHATROLINK-II commands and responses is stored in little endian byte order. For example, 4-byte data “0x1234ABCD” in hexadecimal is stored from the least significant byte as shown below.

Byte	Data
1	CD
2	AB
3	34
4	12

1.4 MECHATROLINK-II Command List

1.4.1 Main Commands (In command code order)

This section provides a table of the main MECHATROLINK-II communications commands used for Σ -7-Series Servo Drives.

Command Code	Command	Function	Reference
00 hex	NOP	Nothing is performed.	3.1.1
01 hex	PRM_RD	Reads the specified parameter.	3.1.13
02 hex	PRM_WR	Saves the specified parameter.	3.1.6
03 hex	ID_RD	Reads the device ID.	3.1.5
04 hex	CONFIG	Enables the current parameter settings.	3.1.8
05 hex	ALM_RD	Reads the current alarm or warning status, and the alarm history.	3.1.15
06 hex	ALM_CLR	Clears the current alarm or warning status, and the alarm history.	3.1.16
0D hex	SYNC_SET	Starts synchronous communications.	3.1.4
0E hex	CONNECT	Requests to establish a MECHATROLINK connection.	3.1.3
0F hex	DISCONNECT	Requests to releases connection.	3.1.2
1C hex	PPRM_WR	Saves the parameters in non-volatile memory.	3.1.7
20 hex	POS_SET	Sets the coordinates.	3.1.17
21 hex	BRK_ON	Turns the brake signal off and applies the holding brake.	8.1
22 hex	BRK_OFF	Turns the brake signal on and release the holding brake.	8.1
23 hex	SENS_ON	Turns the encoder power supply on, and gets the position data.	3.1.9
24 hex	SENS_OFF	Turns the encoder power supply off.	3.1.11
25 hex	HOLD	From current motion status, performs a deceleration stop and positioning according to the deceleration value set in the parameter.	3.2.1
28 hex	LTMOD_ON	Enables the position data latch by the external signal input.	3.2.2
29 hex	LTMOD_OFF	Disables the position data latch by the external signal input.	3.2.3
30 hex	SMON	Monitors the SERVOPACK status.	3.1.14
31 hex	SV_ON	Turns the servo of the motor on.	3.1.10
32 hex	SV_OFF	Turns the servo of the motor off.	3.1.12
34 hex	INTERPOLATE	Starts interpolation feeding.	3.2.4
35 hex	POSING	Starts positioning to the target position (TPOS) at the target speed (TSPD).	3.2.5
36 hex	FEED	Starts constant speed feeding at the target speed (TSPD)	3.2.6
38 hex	LATCH	Performs interpolation feeding and latches the position using the specified latch signal.	3.2.7
39 hex	EX_POSING	Moves toward the target position (TPOS) at the target speed (TSPD). When a latch signal is input midway, positioning is performed according to the final travel distance for external position specified in the parameter from the latch signal input position.	3.2.8
3A hex	ZRET	Performs an origin return operation.	3.2.9
3C hex	VELCTRL	Controls speed.	3.2.10
3D hex	TRQCTRL	Controls torque.	3.2.11
3E hex	ADJ	Used to monitor and adjust data for maintenance.	3.1.18
3F hex	SVCTRL	Performs general-purpose servo control. This command is compatible with MECHATROLINK version 1.0 and earlier.	8.2

1.4.2 Subcommands (In command code order)

The MECHATROLINK-II subcommands used for Σ -7-Series Servo Drives are listed below.

Command Code	Command	Function	Reference
00 hex	NOP	Same function as of the main command NOP	4.2.1
01 hex	PRM_RD	Same function as of the main command PRM_RD	4.2.2
02 hex	PRM_WR	Same function as of the main command PRM_WR	4.2.3
05 hex	ALM_RD	Same function as of the main command ALM_RD	4.2.4
1C hex	PPRM_WR	Same function as of the main command PPRM_WR	4.2.5
28 hex	LTMOD_ON	Same function as of the main command LTMOD_ON	4.2.6
29 hex	LTMOD_OFF	Same function as of the main command LTMOD_OFF	4.2.7
30 hex	SMON	Same function as of the main command SMON	4.2.8

1.4.3 Combination of MECHATROLINK-II Main Commands and Subcommands

Subcommands can be used by combining as listed below.

CODE	Main Command	Subcommand							
		NOP	PRM_RD	PRM_WR	ALM_RD	PPRM_WR	LTMOD_ON	LTMOD_OFF	SMON
00	NOP	√	√	√	√	√	√	√	√
01	PRM_RD	√	×	×	×	×	×	×	√
02	PRM_WR	√	×	×	×	×	×	×	√
03	ID_RD	√	√	√	√	√	√	√	√
04	CONFIG	√	×	×	×	×	×	×	√
05	ALM_RD	√	×	×	×	×	×	×	√
06	ALM_CLR	√	×	×	×	×	×	×	√
0D	SYNC_SET	√	×	×	×	×	×	×	√
0E	CONNECT	√	×	×	×	×	×	×	×
0F	DISCONNECT	√	×	×	×	×	×	×	×
1C	PPRM_WR	√	×	×	×	×	×	×	√
20	POS_SET	√	×	×	×	×	×	×	√
21	BRK_ON	√	×	×	×	×	×	×	√
22	BRK_OFF	√	×	×	×	×	×	×	√
23	SENS_ON	√	×	×	×	×	×	×	√
24	SENS_OFF	√	×	×	×	×	×	×	√
25	HOLD	√	√	√	√	√	√	√	√
28	LTMOD_ON	√	×	×	×	×	×	×	√
29	LTMOD_OFF	√	×	×	×	×	×	×	√
30	SMON	√	√	√	√	√	√	√	√
31	SV_ON	√	√	√	√	√	√	√	√
32	SV_OFF	√	√	√	√	√	√	√	√
34	INTERPOLATE	√	√	√	√	√	√	√	√
35	POSING	√	√	√	√	√	√	√	√
36	FEED	√	√	√	√	√	√	√	√
38	LATCH	√	√	√	√	√	×	×	√
39	EX_POSING	√	√	√	√	√	×	×	√
3A	ZRET	√	√	√	√	√	×	×	√
3C	VELCTRL	√	√	√	√	√	√	√	√
3D	TRQCTRL	√	√	√	√	√	√	√	√
3E	ADJ	√	×	×	×	×	×	×	√
3F	SVCTRL	√	√	√	√	√	×	×	√

Note: √: Can be combined, ×: Cannot be combined

Data Field

2

This chapter describes the data field to be used for the main commands and subcommands.

2.1 Main Command Data Field 2-2

- 2.1.1 Status Field Specifications 2-2
- 2.1.2 OPTION Field Specifications 2-3
- 2.1.3 Monitor Selection Field Specifications:
SEL_MON1/2/3/4 2-4
- 2.1.4 Monitor Information Field Specifications:
MONITOR 1/2/3/4 2-5
- 2.1.5 IO Monitor Field Specifications: IO_MON 2-6
- 2.1.6 LT_SGNL Specifications 2-7

2.2 Substatus Data Field 2-8

- 2.2.1 Substatus Field Specification 2-8
- 2.2.2 Extension Status Field Specifications 2-8

2.1 Main Command Data Field

The data of each field in the main commands or subcommands is described below.

2.1.1 Status Field Specifications

The STATUS field gives the current status of the SERVOPACK.
The following table shows the bit allocation in the status field.

D7	D6	D5	D4	D3	D2	D1	D0
PSET/ V_CMP	ZPOINT	–	PON	SVON	CMDRDY	WARNG	ALM
D15	D14	D13	D12	D11	D10	D9	D8
–	–	N_SOT	P_SOT	NEAR/ V_LIM	L_CMP	T_LIM	DEN/ZSPD

The following table explains each bit value and its status.

Bit	Name	Value	Description
D0	ALM	0	No alarm
		1	Alarm occurs.
D1	WARNG	0	No warning
		1	Warning occurs.
D2	CMDRDY	0	Command cannot be received (busy).
		1	Command can be received (ready).
D3	SVON	0	Servo OFF
		1	Servo ON
D4	PON	0	Main power supply OFF
		1	Main power supply ON
D5	–	–	–
D6	ZPOINT	0	Out of home position range
		1	Within home position range
D7	PSET (During position control)	0	Out of positioning complete range
		1	Within positioning complete range (The output is completed (DEN = 1) and APOS is within the positioning complete range.)
	V_CMP (During speed control)	0	Speed does not coincide.
		1	Speed coincides.
D8	DEN (During position control)	0	During output
		1	Output completed
	ZSPD (During speed control)	0	Zero speed not detected
		1	Zero speed detected
D9	T_LIM	0	Not during torque limit
		1	During torque limit
D10	L_CMP	0	Latch not completed
		1	Latch completed
D11	NEAR (During position control)	0	Out of positioning proximity
		1	Within positioning proximity
	V_LIM (During torque control)	0	Speed limit not detected
		1	Speed limit detected

Continued on next page.

Continued from previous page.

Bit	Name	Value	Description
D12	P_SOT	0	OT signal is off.
		1	OT signal is on.
D13	N_SOT	0	OT signal is OFF.
		1	OT signal is ON.
D14	-	-	-
D15	-	-	-

2.1.2 OPTION Field Specifications

The option field is used to add functions to a motion command.

■ Applicable Commands

SV_ON, HOLD, INTERPOLATE, POSING, FEED, LATCH, EX_POSING, ZRET, VELCTRL, TRQCTRL, SVCTRL

■ Setting Method

Set the functions to be added to a motion command in the main command third and forth bytes reserved for the option field.

The default allocations for Σ -7-Series SERVOPACKs are described below.

To change the default settings, set Pn81F to n.□□□1, and set the bits to which to allocate functions in Pn82A to Pn82E. (Any changes must be enabled by turning the power supply OFF and ON again or by sending a CONFIG command.)

• OPTION Field Default Setting

D7	D6	D5	D4	D3	D2	D1	D0
0	0	0	ACCFIL		0	0	0
D15	D14	D13	D12	D11	D10	D9	D8
N_CL	P_CL	P_PI_CLR	V_PPI	0	0	G_SEL	

- Functions That Can Be Allocated to Bits of the OPTION Field

Name	Description	Value	Details	Default Setting	
ACCFIL (2 bits)	Acceleration/Deceleration filter	0	No acceleration/deceleration filter	D3, D4	
		1	Exponential function acceleration/deceleration		
		2	S-curve acceleration/deceleration		
		3	Do not set.		
G_SEL (2 bits)	Gain switching	0	First gain	D8, D9	
		1	Second gain		
		2	Reserved (invalid)		
		3	Reserved (invalid)		
V_PPI (1 bit)	Speed loop P/PI control	0	PI control	D12	
		1	P control		
P_PI_CLR (1 bit)	Position loop position integral clear	0	Does not clear.	D13	
		1	Clears.		
P_CL (1 bit)	Forward torque limit	0	Does not control torque.	D14	
		1	Controls torque.		
N_CL (1 bit)	Reverse torque limit	0	Does not control torque.	D15	
		1	Controls torque.		
LT_DISABLE (1 bit)	Latch signal input disabled	0	Enables latch signal input.	Not allocated	
		1	Disables latch signal input.		
BANK_SEL1 (4 bits)	Bank selector 1 (Bank for acceleration/deceleration parameter switching)	0 to 15	Bank 0 to Bank 15	Not allocated	
OUT_SIGNAL (3 bits)	I/O signal output command	BIT 0	0	SO1 output signal OFF	Not allocated
			1	SO1 output signal ON	
		BIT 1	0	SO2 output signal OFF	
			1	SO2 output signal ON	
		BIT 2	0	SO3 output signal OFF	
			1	SO3 output signal ON	

Note: 1. Do not allocate more than one signal to one bit. Otherwise, multiple signals will be controlled by one bit.
 2. The bits to which no function is allocated will act as it is set to 0 (zero).
 3. To enable the OUT_SIGNAL function, set the following parameters to Zero: Pn50E, Pn50F, and Pn510.

2.1.3 Monitor Selection Field Specifications: SEL_MON1/2/3/4

The monitor selection (SEL_MON1/2/3/4) field is used to select the Servo monitor information.

■ Applicable Commands

SV_ON, SV_OFF, HOLD, INTERPOLATE, POSING, FEED, LATCH, EX_POSING, ZRET, VELCTRL, TRQCTRL, SMON, SENS_ON, SENS_OFF, BRK_ON, BRK_OFF, LTMOD_ON, LTMOD_OFF

■ Setting Method

Set MONITOR 1/2/3/4 monitor codes in SEL_MON1/2/3/4 allocated in the thirteenth byte of the main command or in the reserved area of the nineteenth byte of the subcommand.

SEL_MON1/2/3/4 allocation is shown below.

D7	D6	D5	D4	D3	D2	D1	D0
SEL_MON2				SEL_MON1			
D7	D6	D5	D4	D3	D2	D1	D0
SEL_MON4				SEL_MON3			

2.1.4 Monitor Information Field Specifications: MONITOR 1/2/3/4

The monitor information (MONITOR 1/2/3/4) field is used to monitor information selected by the monitor codes in the monitor selection field.

■ Applicable Commands

SV_ON, SV_OFF, HOLD, INTERPOLATE, POSING, FEED, LATCH, EX_POSING, ZRET, VELCTRL, TRQCTRL, SMON, SENS_ON, SENS_OFF, BRK_ON, BRK_OFF, LTMOD_ON, LTMOD_OFF

The MONITOR 1/2/3/4 monitor codes are listed below.

Monitor Code	Name	Description	Unit
0	POS	Reference position in reference coordinate system (position after reference filtering)	Reference unit
1	MPOS	Reference position	Reference unit
2	PERR	Position error (Effective only during position control)	Reference unit
3	APOS	Feedback position in machine coordinate system	Reference unit
4	LPOS	Feedback latch position in machine coordinate system	Reference unit
5	IPOS	Reference position in reference coordinate system (position before reference filtering)	Reference unit
6	TPOS	Target position in reference coordinate system	Reference unit
7	–	–	–
8	FSPD	Feedback speed	Position/torque control: Reference units/s Speed control: Maximum speed/40000000 hex
9	CSPD	Reference speed	Position control: Reference units/s Speed control: Maximum speed/40000000 hex
A	TSPD	Target speed	Position control: Reference units/s Speed control: Maximum speed/40000000 hex
B	TRQ	Torque reference (The rated torque is 100%.)	Position/speed control: % (The rated torque is 100%.) Torque control: Maximum torque/40000000 hex
C	–	–	–
D	–	–	–
E	OMN1	Option monitor 1 selected in Pn824	–
F	OMN2	Option monitor 2 selected in Pn825	–

2.1.5 IO Monitor Field Specifications: IO_MON

The IO monitor field is used to monitor the I/O signal status of the SERVOPACK.

■ Applicable Commands

SMON, SV_ON, SV_OFF, SV_CTRL, FEED, HOLD, INTERPOLATE, POSING, LATCH, EX_POSING, ZRET, VELCTRL, TRQCTRL, SENS_ON, SENS_OFF, BRK_ON, BRK_OFF, LTMOD_ON, LTMOD_OFF

I/O signal allocation is shown below.

D7	D6	D5	D4	D3	D2	D1	D0
EXT2	EXT1	PC	PB	PA	DEC	N_OT	P_OT

D15	D14	D13	D12	D11	D10	D09	D08
IO15	IO14	IO13	IO12	–	HBB	BRK	EXT3

Bit	Name	Contents	Value	Status
D0	P_OT	Forward run prohibited input	0	OFF
			1	ON
D1	N_OT	Reverse run prohibited input	0	OFF
			1	ON
D2	DEC	Homing deceleration LS input	0	OFF
			1	ON
D3	PA	Encoder phase A input	0	OFF
			1	ON
D4	PB	Encoder phase B input	0	OFF
			1	ON
D5	PC	Encoder phase C input	0	OFF
			1	ON
D6	EXT1	First external latch signal input	0	OFF
			1	ON
D7	EXT2	Second external latch signal input	0	OFF
			1	ON
D8	EXT3	Third external latch signal input	0	OFF
			1	ON
D9	BRK	Brake output	0	Released
			1	Locked
D10	HBB	Stop signal input, OR of HWBB1 signal and HWBB2 signal	0	OFF (Forced stop released)
			1	ON (Forced stop)
D11	–	Reserved	0	–
D12	IO12	CN1 input signal selected in Pn81E = n.□□□X	0	OFF (open)
			1	ON (closed)
D13	IO13	CN1 input signal selected in Pn81E = n.□□X□	0	OFF (open)
			1	ON (closed)
D14	IO14	CN1 input signal selected in Pn81E = n.□X□□	0	OFF (open)
			1	ON (closed)
D15	IO15	CN1 input signal selected in Pn81E = n.X□□□	0	OFF (open)
			1	ON (closed)

2.1.6 LT_SGNL Specifications

■ Applicable Commands

LATCH, EX_POSING, ZRET, LTMOD_ON (When Pn850 = 0), SVCTRL

The latch signal can be specified in the following latch signal (LT_SGNL) field.

D7	D6	D5	D4	D3	D2	D1	D0
0	0	0	0	0	0	LT_SGNL	

D1	D0	Latch Signal	Signal Details
0	0	Phase C	Encoder origin signal
0	1	EXT1	External input signal 1
1	0	EXT2	External input signal 2
1	1	EXT3	External input signal 3

2.2 Substatus Data Field

2.2.1 Substatus Field Specification

The substatus field is used to monitor status of subcommands.

Byte	D7	D6	D5	D4	D3	D2	D1	D0
18	Reserved	Reserved	Reserved	Reserved	Reserved	SBCM-DRDY	SBWARN G	SBALM

Bit	Name	Description	Value	Status
D0	SBALM	Subcommand alarm occurs.	0	No alarm
			1	Alarm occurs
D1	SBWARN G	Subcommand warning occurs.	0	No warning
			1	Warning
D2	SBCMDRDY	Subcommand Ready (Subcommand can be received)	0	Busy
			1	Ready

2.2.2 Extension Status Field Specifications

The EX_STATUS field gives the current extended status.

The SMON, LTMOD_ON, and LTMOD_OFF subcommands can be used to enable monitoring.

Byte	D7	D6	D5	D4	D3	D2	D1	D0
28	L_CMP_CNT							
Byte	D15	D14	D13	D12	D11	D10	D9	D8
29	-	-	-	-	L_SEQ_NO			

- L_CMP_CNT (D0-D7)
This counter indicates how many times the latch sequence has been completed during continuous latch operation. It remains 0 during a normal latch operation.
- L_SEQ_NO (D8-D11)
This number indicates the number of latch sequence being completed during a continuous latch operation. It remains 0 during a normal latch operation.

Main Commands

3

This chapter describes the MECHATROLINK-II main commands.

3.1 Commands Used to Prepare for Operation 3-3

- 3.1.1 NOP (No Operation) Command: 00 Hex 3-3
- 3.1.2 DISCONNECT (Release Connection)
Command: 0F Hex 3-5
- 3.1.3 CONNECT (Establish MECHATROLINK-II
Connection) Command: 0E Hex 3-6
- 3.1.4 SYNC_SET (Start Synchronous Communications)
Command: 0D Hex 3-8
- 3.1.5 ID_RD (Check Device ID) Command: 03 Hex . . . 3-9
- 3.1.6 PRM_WR (Set Parameter) Command: 02 Hex . . 3-11
- 3.1.7 PPRM_WR (Set and Save Parameters
in Non-volatile Memory) Command: 1C Hex . . . 3-12
- 3.1.8 CONFIG (Enable Parameters) Command:
04 Hex 3-13
- 3.1.9 SENS_ON (Turn ON Encoder Power Supply)
Command: 23 Hex 3-14
- 3.1.10 SV_ON (Turn ON Servo) Command: 31 Hex . . . 3-15
- 3.1.11 SENS_OFF (Turn OFF Encoder Power Supply)
Command: 24 Hex 3-16
- 3.1.12 SV_OFF (Turn Servo OFF) Command: 32 Hex . . 3-17
- 3.1.13 PRM_RD (Read Parameter) Command:
01 Hex 3-18
- 3.1.14 SMON (Check SERVOPACK Status)
Command: 30 Hex 3-19
- 3.1.15 ALM_RD (Read Alarm or Warning)
Command: 05 Hex 3-20
- 3.1.16 ALM_CLR (Clear Warnings and Alarms)
Command: 06 Hex 3-22
- 3.1.17 POS_SET (Set Coordinate System)
Command: 20 Hex 3-23

3.1.18	ADJ (Monitor and Adjust Settings)	
	Command: 3E Hex	3-24

3.2 Motion Commands 3-28

3.2.1	HOLD (Stop Motion) Command: 25 Hex	3-28
3.2.2	LTMOD_ON (Set Latch Mode)	
	Command: 28 Hex	3-30
3.2.3	LTMOD_OFF (Release Latch Mode)	
	Command: 29 Hex	3-33
3.2.4	INTERPOLATE (Interpolation Feeding)	
	Command: 34 Hex	3-34
3.2.5	POSING (Positioning) Command: 35 Hex	3-36
3.2.6	FEED (Constant Speed Feeding)	
	Command: 36 Hex	3-38
3.2.7	LATCH (Interpolation Feeding with	
	Position Detection) Command: 38 Hex	3-40
3.2.8	EX_POSING (External Input Positioning)	
	Command: 39 Hex	3-42
3.2.9	ZRET (Origin Return) Command: 3A Hex	3-44
3.2.10	VELCTRL (Velocity Control)	
	Command: 3C Hex	3-46
3.2.11	TRQCTRL (Torque Control)	
	Command: 3D Hex	3-48
3.2.12	Restrictions in Using Servo Commands	3-50

3.1 Commands Used to Prepare for Operation

3.1.1 NOP (No Operation) Command: 00 Hex

After turning on the control and main circuit power supplies, send NOP command to check if initialization of SERVOPACK has been completed or not.

NOP Command

The specifications of the NOP command are shown below.

Byte	NOP		Description				
	Command	Response					
1	00 hex	00 hex	Phases in which the command can be executed	All phases	Synchronization classification	Asynchronous command	
2	-	ALARM	Processing time	Within communications cycle	Subcommand	Can be used.	
3		STATUS	-	<ul style="list-style-type: none"> Returns the ALM, WARNG, and CMDRDY bits in STATUS field. Other bits will not be specified. The response will be NOP from the moment the power is turned on until the initialization of SERVOPACK is completed. During this time, CMDRY = 0. 			
4							
5							
6							
7							
8							
9							
10							
11							
12							
13							
14							
15							
16	WDT	RWDT					
17	Subcommand area	Subcommand area					
18							
19							
20							
21							
22							
23							
24							
25							
26							
27							
28							
29							

ALARM

The uppermost two digits of the SERVOPACK alarm code are set in the ALARM field of the response. For example, ALARM = 02 when an A.020 alarm (Parameter Checksum Error) occurs.

If no alarm occurs, ALARM = 00.

Refer to your SERVOPACK manual for details on alarms and alarm codes.

Status Field Specifications

The STATUS field gives the current status of the SERVOPACK.
The following table shows the bit allocation in the status field.

D7	D6	D5	D4	D3	D2	D1	D0
PSET/ V_CMP	ZPOINT	–	PON	SVON	CMDRDY	WARNG	ALM
D15	D14	D13	D12	D11	D10	D9	D8
–	–	N_SOT	P_SOT	NEAR/ V_LIM	L_CMP	T_LIM	DEN/ZSPD

The following table explains each bit value and its status.

Bit	Name	Value	Description
D0	ALM	0	No alarm
		1	Alarm occurs.
D1	WARNG	0	No warning
		1	Warning occurs.
D2	CMDRDY	0	Command cannot be received (busy).
		1	Command can be received (ready).
D3	SVON	0	Servo OFF
		1	Servo ON
D4	PON	0	Main power supply OFF
		1	Main power supply ON
D5	–	–	–
D6	ZPOINT	0	Out of home position range
		1	Within home position range
D7	PSET (During position control)	0	Out of positioning complete range
		1	Within positioning complete range (The output is completed (DEN = 1) and APOS is within the positioning complete range.)
	V_CMP (During speed control)	0	Speed does not coincide.
		1	Speed coincides.
D8	DEN (During position control)	0	During output
		1	Output completed
	ZSPD (During speed control)	0	Zero speed not detected
		1	Zero speed detected
D9	T_LIM	0	Not during torque limit
		1	During torque limit
D10	L_CMP	0	Latch not completed
		1	Latch completed
D11	NEAR (During position control)	0	Out of positioning proximity
		1	Within positioning proximity
	V_LIM (During speed control)	0	Speed limit not detected
		1	Speed limit detected
D12	P_SOT	0	OT signal is OFF.
		1	OT signal is ON.
D13	N_SOT	0	OT signal is OFF.
		1	OT signal is ON.
D14	–	–	–
D15	–	–	–

Details WDT and RWDT

The watchdog timer data will be set in WDT and RWDT of NOP command and response as shown below.

	D7	D4 D3	D0	
WDT	SN: Copy of RSN in RWDT		MN: Incremented by 1 each communications cycle	MN: Master station watchdog timer count
	D7	D4 D3	D0	
RWDT	RSN: Incremented by 1 each communications cycle		RMN: Copy of MIN in WDT	RSN: SERVOPACK's watchdog timer count

The watchdog timer is checked after synchronous communications has been established. The SERVOPACK watchdog timer data will be refreshed whether synchronous communications is established or not.

3.1.2 DISCONNECT (Release Connection) Command: 0F Hex

The DISCONNECT command releases a connection at the end of communications.

DISCONNECT Command

The specifications of the DISCONNECT command are shown below.

Byte	DISCONNECT		Description			
	Command	Response				
1	0F hex	0F hex	Phases in which the command can be executed	All phases	Synchronization classification	Asynchronous command
2		ALARM	Processing time	Communications cycle or more (Within 5 s)	Subcommand	Cannot be used
3	-	STATUS	<ul style="list-style-type: none"> Releases the MECHATROLINK-II connection, and the SERVOPACK changes communications to Phase 1. When this command is received, the following operations will be performed. <ul style="list-style-type: none"> The SERVOPACK changes communications to Phase 1. The SERVOPACK changes to Servo OFF. The reference point setting becomes invalid. The position data is initialized. BRAKE signal turns ON. If an alarm has occurred, releasing the connection will not clear the alarm status. The set parameter data (saved in the volatile memory) will remain valid. To re-establish connection, carry out operations in the same sequence as when turning ON the power supply and set the required parameters again. 			
4						
5						
6						
7						
8						
9						
10						
11						
12						
13						
14						
15	-					
16	WDT	RWDT				

Note: Always send a DISCONNECT command for at least two communications cycles.

3.1.3 CONNECT (Establish MECHATROLINK-II Connection) Command: 0E Hex

Send a CONNECT command to establish a MECHATROLINK-II communications connection. When the connection is established, the WDT (watchdog timer) count starts.

CONNECT Command

The specifications of the CONNECT command are shown below.

Byte	CONNECT		Description			
	Command	Response				
1	0E hex	0E hex	Phases in which the command can be executed	Phase 1	Synchronization classification	Asynchronous command
2	-	ALARM	Processing time	Communications cycle or more (Within 5 s)	Subcommand	Cannot be used
3		STATUS	<ul style="list-style-type: none"> Establishes a MECHATROLINK-II connection and sets the communications mode according to COM_MODE. VER: Version. Set VER to 21 hex (Version 2.1) COM_MOD: Sets the communications mode. Refer to the following section for details.  Details of COM_MOD on page 3-7 COM_TIM: Sets the communications cycle. The communications cycle must satisfy the following equation within the range between 1 and 32. $0.25 \text{ [ms]} \leq \text{Transmission cycle [ms]} \times \text{COM_TIM} \leq 32 \text{ [ms]}$ A warning will occur and the command will be ignored in the following cases. <ul style="list-style-type: none"> If COM_MODE is out of the setting range: A.94B alarm (Data Setting Warning 2) If COM_TIM is out of the setting range: A.94B alarm (Data Setting Warning 2) If the transmission bytes is 17 but SUBCMD = 1: A.94B alarm (Data Setting Warning 2) If the transmission speed is set to 10 Mbps but VER is not set to 21 hex: A.94B alarm (Data Setting Warning 2) Slave stations will not accept commands other than CONNECT, DISCONNECT, and NOP before the connection is established. If a command other than CONNECT, DISCONNECT, and NOP is sent before the connection is established, NOP is always returned as the response. 			
4						
5	VER	VER				
6	COM_MOD	COM_MOD				
7	COM_TIM	COM_TIM				
8	-	-				
9						
10						
11						
12						
13						
14						
15						
16	WDT	RWDT				

Note: Slave stations will not accept any MECHATROLINK-II command while a motion command such as JOG is being executed to run the motor through SigmaWin or by digital operator.

Details of COM_MOD

COM_MOD bit allocation and each bit status are described below.

D7	D6	D5	D4	D3	D2	D1	D0
SUBCMD	0	0	0	DTMOD		SYNCMOD	0

■ SYNCMOD

Sets the synchronization mode.

SYNCMOD = 0: Asynchronous communications

SYNCMOD = 1: Synchronous communications

■ DTMOD

Sets the data transmission method.

DTMOD = 00 or 11: Single transmission

DTMOD = 01: Continuous transmission

Normally, set DTMOD to 00.

■ SUBCMD

Specify whether to use subcommands or not.

SUBCMD = 0: Do not use subcommands

SUBCMD = 1: Use subcommands

Note: When SYNCMOD = 0, it is necessary to send SYNC_SET command to enter Phase 3.

Warning

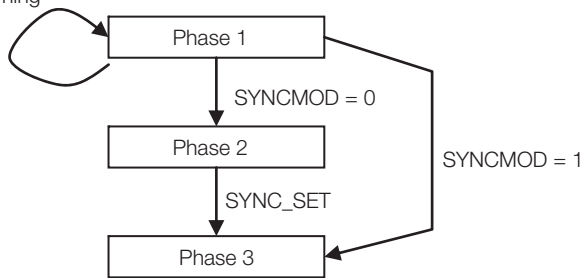

Transmission Cycle and Communications Cycle

The table below provides the applicable communications cycle and the maximum number of connectable stations for each transmission cycle setting.

Transmission Cycle	Applicable Communications Cycle	Transmission Bytes	
		17-byte	32-byte
		Connectable Max. Number of Stations	
0.25 ms	0.25 ms to 8.00 ms (in 0.25-ms units)	2	1
0.50 ms	0.50 ms to 16.00 ms (in 0.50-ms units)	7	4
0.75 ms	0.75 ms to 24.00 ms (in 0.75-ms units)	11	7
1.00 ms	1.00 ms to 32.00 ms (in 1.00-ms units)	15	9
1.50 ms	1.50 ms to 32.00 ms (in 1.50-ms units)	23	15
2.00 ms	2.00 ms to 32.00 ms (in 2.00-ms units)	30	21
2.50 ms	2.50 ms to 32.00 ms (in 2.50-ms units)	30	26
3.00 ms	3.00 ms to 32.00 ms (in 3.00-ms units)	30	30
3.50 ms	3.50 ms to 32.00 ms (in 3.50-ms units)	30	30
4.00 ms	4.00 ms to 32.00 ms (in 4.00-ms units)	30	30

Note: Communications retry stations can be connected as long as the total number of connected stations, including the retry stations, is within the connectable max. number of stations. The maximum number of retry stations is the difference between the connectable max. number of stations and the number of actually connected slave stations, but limited to 7.

Note that the connectable max. number of stations may differ depending on the controller specifications.

3.1.4 SYNC_SET (Start Synchronous Communications) Command: 0D Hex

This command is used to start synchronous communications and change from phase 2 to phase 3.

When SYNCMOD bit of the COM_MOD of CONNECT command is set to 1, the communications phase will change from phase 1 to phase 3 at the moment the connection is established. In this case, it is not necessary to send a SYNC_SET command.

SYNC_SET Command

The specifications of the SYNC_SET command are described below.

Byte	SYNC_SET		Description				
	Command	Response					
1	0D hex	0D hex	Phases in which the command can be executed	Phase 2	Synchronization classification	Asynchronous command	
2	-	ALARM	Processing time	Communications cycle or more (Within 5 s)	Subcommand	Cannot be used	
3		STATUS	-	<ul style="list-style-type: none"> Starts synchronous communications. Switched from phase 2 to phase 3. Synchronization is made at the WDT changing edge. However, if WDT errors are masked (Pn800 = n.□□□2), processing is completed when this command is received. During phase 3, the slave ignores this command and returns a normal response without a warning. If the slave station in Servo ON status receives this command in phase 2, the slave station enters Servo OFF status. At occurrence of the following alarms and warnings, this command must be transmitted to restart synchronous communications. <ul style="list-style-type: none"> An A.95A alarm (Command Warning 1) will occur if this command is used in phase 1. A.E50 alarm (MECHATROLINK Synchronization Error) A.E51 alarm (MECHATROLINK Synchronization Failed) A.E60 alarm (MECHATROLINK Communications Error) A.E61 alarm (MECHATROLINK Transmission Cycle Error) An A.95A alarm (Command Warning 1) will occur if this command is used while operating the SERVOPACK with SigmaWin or a Digital Operator. 			
4							
5							
6							
7							
8							
9							
10							
11							
12		-	-				
13							
14							
15							
16	WDT	RWDT					

3.1.5 ID_RD (Check Device ID) Command: 03 Hex

Send ID_RD command to read the device ID for confirmation.

ID_RD Command

The specifications of the ID_RD command are described below.

Byte	ID_RD		Description			
	Command	Response				
1	03 hex	03 hex	Phases in which the command can be executed	Phase 2 and 3	Synchronization classification	Asynchronous command
2	-	ALARM	Processing time	Within communications cycle	Subcommand	Can be used
3		STATUS	<ul style="list-style-type: none"> Reads the device ID for confirmation. Use DEVICE_CODE to specify the device ID to be read. Use OFFSET to specify which data of the device ID is to be read out. Use SIZE to specify the number of data (bytes) to be read out. A warning will occur and the command will be ignored in the following case. <ul style="list-style-type: none"> DEVICE_CODE is set out of the range: A.94B alarm (Data Setting Warning 2) 			
4						
5		DEVICE_CODE		DEVICE_CODE		
6	OFFSET	OFFSET				
7	SIZE	SIZE				
8	-	ID				
9						
10						
11						
12						
13						
14						
15						
16	WDT	RWDT				
17	Subcommand area	Subcommand area				
18						
19						
20						
21						
22						
23						
24						
25						
26						
27						
28						
29						

Device ID Specifications

The specifications of the device ID are described below.

Device Type/Name		DEVICE_CODE	OFFSET																	
			00	01	02	03	04	05	06	07	08	09	0A	0B	0C	0D	0E	0F	10	11
SERVO-PACK	Model	00 hex	S	G	D	*1	*1	*2	*2	*2	*3	*4	*4	*5	*6	*6	*6	*6	*6	00
	Software version	02 hex	Ver.																	
Servo-motor	Model	20 hex	S	G	M	*7	*7	-	*8	*8	*9	*10	*11	*12	*13	00				
	Encoder software version	12 hex	Ver.																	
External Encoder	Model	30 hex																		
	Software version	32 hex	Ver.																	
Safety Option Unit	Model	60 hex																		
	Software version	62 hex	Ver.																	
Feedback Option Unit	Model	70 hex																		
	Software version	72 hex	Ver.																	

- SERVO-PACK Model
 *1: Model code, *2: Current capacity, *3: Power supply voltage specifications, *4: Interface specifications, *5: Design revision order, *6: Options
- Servomotor Model
 *7: Model code, *8: Rated output, *9: Power supply voltage, *10: Encoder type, *11: Design revision order, *12: Shaft-end specifications, *13: Options
- Software version is binary data.
- The models are given in ASCII characters and 00 (null) is added to the end of each character string.
- 50 hex and 52 hex of DEVICE_CODE are reserved for system.
- When the Safety Option unit or/and Feedback Option unit are not connected, 0 is set to all the ID data.
- For an external encoder, the ID of the encoder connected to the Feedback Option unit is set. (Therefore, 0 is set to all the ID data when no Feedback Option unit is connected.)
- When an encoder option for fully-closed loop control is connected to the Feedback Option unit, 0 is set to all the ID data of Feedback Option unit.

3.1.6 PRM_WR (Set Parameter) Command: 02 Hex

Parameters will be set without being saved in the non-volatile memory of SERVOPACK. Send PRM_WR command to set parameters when parameters are managed by a controller.

PRM_WR Command

The specifications of the PRM_WR command are described below.

Byte	PRM_WR		Description			
	Command	Response				
1	02 hex	02 hex	Phases in which the command can be executed	Phase 2 and 3	Synchronization classification	Asynchronous command
2	-	ALARM	Processing time	Within 200 ms	Subcommand	Cannot be used
3		STATUS	<ul style="list-style-type: none"> Writes parameters. The parameters will not be saved in the non-volatile memory. For parameters that require turning the power supply OFF and ON again to be validated, it is necessary to send a CONFIG command to validate the settings. However, the following parameters are not enabled even if the CONFIG command is sent. You must turn the power supply OFF and ON again after you change either of these parameters. <ul style="list-style-type: none"> Pn002 = n.X□□□ (External Encoder Usage) Pn00C (Application Function Selections C) Use NO to specify the parameter to be written. Use SIZE to specify the number of data (bytes) of the parameter to be written. PARAMETER is the data to be written. A warning will occur and the command will be ignored in the following cases. <ul style="list-style-type: none"> When writing parameters that affect utility functions currently being used for operations with SigmaWin or a digital operator: A.95A alarm (Command Warning 1) NO is set out of the range: A.94A alarm (Data Setting Warning 1) SIZE does not match: A.94D alarm (Data Setting Warning 4) PARAMETER is out of the range: A.94B alarm (Data Setting Warning 2) 			
4						
5	NO	NO		PARAMETER	PARAMETER	
6						
7	SIZE	SIZE				
8	PARAMETER	PARAMETER				
9						
10						
11						
12						
13						
14						
15						
16	WDT	RWDT				

- Example of NO
For the parameter Pn80D, the data is set in little endian as shown below.

Byte	Data
5	0D
6	08

3.1.7 PPRM_WR (Set and Save Parameters in Non-volatile Memory) Command: 1C Hex

This command is used to set parameters and save them in nonvolatile memory in the SERVO-PACK.

PPRM_WR Command

The specifications of the PPRM-WR command are described below.

Byte	PPRM_WR		Description			
	Command	Response				
1	1C hex	1C hex	Phases in which the command can be executed	Phase 2 and 3	Synchronization classification	Asynchronous command
2	-	ALARM	Processing time	Within 200 ms	Subcommand	Cannot be used
3		STATUS	<ul style="list-style-type: none"> Saves parameters in the non-volatile memory. For parameters that require turning the power supply OFF and ON again to be validated, it is necessary to send a CONFIG command to validate the settings. However, the following parameters are not enabled even if the CONFIG command is sent. You must turn the power supply OFF and ON again after you change either of these parameters. <ul style="list-style-type: none"> Ph002 = n.X□□□ (External Encoder Usage) Ph00C (Application Function Selections C) A warning will occur and the command will be ignored in the following cases. <ul style="list-style-type: none"> NO is out of the range: A.94A alarm (Data Setting Warning 1) SIZE does not match: A.94D alarm (Data Setting Warning 4) PARAMETER is out of the range: A.94B alarm (Data Setting Warning 2) When writing parameters that affect utility functions currently being used for operations with SigmaWin or a digital operator: A.95A alarm (Command Warning 1) 			
4	NO	NO				
5		SIZE		SIZE		
6						
7	PARAMETER	PARAMETER				
8						
9						
10						
11						
12						
13						
14	WDT	RWDT				



Important

Do not turn off the power supply while the parameter is being written (CMDRDY = 0).

3.1.8 CONFIG (Enable Parameters) Command: 04 Hex

The set parameters need to be validated (setup) using a CONFIG command.

Executing this command recalculates all currently set parameters and initializes positions, output signals, etc.

CONFIG Command

The specifications of the CONFIG command are described below.

Byte	CONFIG		Description			
	Command	Response				
1	04 hex	04 hex	Phases in which the command can be executed	Phase 2 and 3	Synchronization classification	Asynchronous command
2	-	ALARM	Processing time	Within 5 s	Subcommand	Cannot be used
3		STATUS	-			<ul style="list-style-type: none"> Recalculates all currently set parameters and initializes position, etc. The SERVOPACK will change to Servo OFF if this command is received when the SERVOPACK is Servo ON. A warning will occur and the command will be ignored if this command is sent: <ul style="list-style-type: none"> When using SigmaWin or a digital operator to execute utility functions: A.95A alarm (Command Warning 1) Refer to the following section for details on status and output signals during command execution. <ul style="list-style-type: none">  <i>Status and Output Signal during CONFIG Command Execution on page 3-13</i>
4						
5						
6						
7						
8						
9						
10						
11						
12						
13						
14						
15						
16	WDT	RWDT				

Status and Output Signal during CONFIG Command Execution

The status and output signal during CONFIG command execution are listed below.

Status and Output Signal	Before CONFIG	During CONFIG	After CONFIG
ALM (status)	Current status	Current status	Current status
CMDRDY (status)	1	0	1
Other status	Current status	Not specified	Current status
ALARM (code)	Alarm currently occurred	Alarm currently occurred	Alarm currently occurred
ALM (CN1 output signal)	Current status	Current status	Current status
/S-RDY (CN1 output signal)	Current status	OFF	Current status
Other output signals	Current status	Not specified	Current status

3.1.9 SENS_ON (Turn ON Encoder Power Supply) Command: 23 Hex

This command turns ON the power supply to the encoder.

SENS_ON Command

The specifications of the SENS_ON command are described below.

Byte	SENS_ON		Description			
	Command	Response				
1	23 hex	23 hex	Phases in which the command can be executed	Phase 2 and 3	Synchronization classification	Asynchronous command
2	-	ALARM	Processing time	Within 2 s	Subcommand	Cannot be used
3		STATUS	<ul style="list-style-type: none"> Obtains the initial position data and creates the present position when an absolute encoder is used. The reference point, home position (ZPOINT), and software limits will be enabled when an absolute encoder is used. After having used this command, the position data must be monitored and the coordinate system of host controller must be setup. 			
4		MONITOR1				
5						
6						
7						
8						
9						
10						
11						
12		MONITOR2				
13		SEL_MON1/2	SEL_MON1/2			
14	-	IO_MON				
15						
16	WDT	RWDT				

3.1.10 SV_ON (Turn ON Servo) Command: 31 Hex

This command supplies power to the Servomotor to enable operation.

SV_ON Command

The specifications of the SV_ON command are described below.

Byte	SV_ON		Description				
	Command	Response					
1	31 hex	31 hex	Phases in which the command can be executed	Phase 2 and 3	Synchronization classification	Asynchronous command	
2	–	ALARM	Processing time	Normally 50 ms (10 s max.)	Subcommand	Can be used	
3	OPTION	STATUS	<ul style="list-style-type: none"> • Powers the servomotor and makes it ready for operation. • An A.95A alarm (Command Warning 1) will occur and the command will be ignored if the command is sent: <ul style="list-style-type: none"> • During alarm occurrence (When ALM of STATUS is 1) • When the main power supply is OFF (PON of STATUS is 0) • When the HWBB signal is ON (HWBB of IO_MON is 1) • Before completion of execution of SENS_ON when an absolute encoder is used • OPTION field can be selected • Upon completion of execution of this command, the reference position (POS) must be read, and the controller coordinate system must be set up. 				
4							
5	–	MONITOR1					
6							
7							
8							
9							MONITOR2
10							
11							
12							
13	SEL_MON1/2	SEL_MON1/2					
14	–	IO_MON					
15							
16	WDT	RWDT					
17	Subcommand area	Subcommand area					
18							
19							
20							
21							
22							
23							
24							
25							
26							
27							
28							
29							

3.1.11 SENS_OFF (Turn OFF Encoder Power Supply) Command: 24 Hex

Send a SENS_OFF command to turn OFF the encoder power supply.

SENS_OFF Command

The specifications of the SENS_OFF command are described below.

Byte	SENS_OFF		Description			
	Command	Response				
1	24 hex	24 hex	Phases in which the command can be executed	Phase 2 and 3	Synchronization classification	Asynchronous command
2	-	ALARM	Processing time	Within 2 sec	Subcommand	Cannot be used
3		STATUS	<ul style="list-style-type: none"> Turn the encoder OFF. The position data will not be specified when an absolute encoder is used. The reference point, origin (ZPOINT), and software limits will be invalid. An A.95A alarm (Command Warning 1) will occur and the command will be ignored if the command is sent: <ul style="list-style-type: none"> While the servo is ON 			
4						
5		MONITOR1				
6						
7						
8						
9						
10						
11		MONITOR2				
12						
13		SEL_MON1/2		SEL_MON1/2		
14		-		IO_MON		
15						
16	WDT	RWDT				

3.1.12 SV_OFF (Turn Servo OFF) Command: 32 Hex

This command turns OFF the power supply to the Servomotor.

SV_OFF Command

The specifications of the SV_OFF command are described below.

Byte	SV_OFF		Description					
	Command	Response						
1	32 hex	32 hex	Phases in which the command can be executed	Phase 2 and 3	Synchronization classification	Asynchronous command		
2	-	ALARM	Processing time	The time set in Pn506 (500 ms max.)	Subcommand	Can be used		
3		-	STATUS	<ul style="list-style-type: none"> Stops current flow through the servomotor. When Pn829 (SVOFF Waiting Time (for SVOFF at Deceleration to Stop) is set to a value other than 0, the servo will be turned OFF after the servomotor decelerates to a stop according to the deceleration constant for stopping set by the parameter. (The servomotor decelerates to a stop in position control mode.) When Pn829 (SVOFF Waiting Time (for SVOFF at Deceleration to Stop) is set to 0, the servo will be turned OFF immediately after reception of this command. (The control mode from before receiving the SV_OFF command is not changed.) Executing the SV_OFF command will cancel the speed reference, speed feed forward, torque feed forward, and torque limits set by a position/speed control command. 				
4								
5			MONITOR1					
6								
7								
8								
9								MONITOR2
10								
11								
12			SEL_MON1/2					SEL_MON1/2
13			-					IO_MON
14								
15	WDT	RWDT						
16	Subcommand area	Subcommand area						
17								
18								
19								
20								
21								
22								
23								
24								
25								
26								
27								
28								
29								

3.1.13 PRM_RD (Read Parameter) Command: 01 Hex

This command reads parameters.

PRM_RD Command

The specifications of the PRM_RD command are described below.

Byte	PRM_RD		Description			
	Command	Response				
1	01 hex	01 hex	Phases in which the command can be executed	Phase 2 and 3	Synchronization classification	Asynchronous command
2	-	ALARM	Processing time	Within 200 ms	Subcommand	Can be used
3		STATUS	<ul style="list-style-type: none"> Reads out parameters. A warning will occur and the command will be ignored in the following cases. <ul style="list-style-type: none"> NO is out of the range: A.94A alarm (Data Setting Warning 1) SIZE does not match: A.94D alarm (Data Setting Warning 4) 			
4	NO	NO				
5						
6						
7				SIZE	SIZE	
8	-	PARAMETER				
9						
10						
11						
12						
13						
14						
15						
16	WDT	RWDT				

3.1.14 SMON (Check SERVOPACK Status) Command: 30 Hex

This command reads SERVOPACK status.

SMON Command

The specifications of the SMON command are described below.

Byte	SMON		Description				
	Command	Response					
1	30 hex	30 hex	Phases in which the command can be executed	Phase 2 and 3	Synchronization classification	Asynchronous command	
2	-	ALARM	Processing time	Within communications cycle	Subcommand	Can be used	
3		STATUS	<ul style="list-style-type: none"> Reads the current status of the SERVOPACK. 				
4		MONITOR1					
5							
6							
7							
8							
9							
10		MONITOR2					
11							
12							
13		SEL_MON1/2					SEL_MON1/2
14		-					IO_MON
15							
16	WDT	RWDT					
17	Subcommand area	Subcommand area					
18							
19							
20							
21							
22							
23							
24							
25							
26							
27							
28							
29							

3.1.15 ALM_RD (Read Alarm or Warning) Command: 05 Hex

This command reads the current alarms and warnings and the alarm history.

ALM_RD Command

The specifications of the ALM_RD command are described below.

Byte	ALM_RD		Description			
	Command	Response				
1	05 hex	05 hex	Phases in which the command can be executed	Phase 2 and 3	Synchronization classification	Asynchronous command
2	-	ALARM	Processing time	See <i>ALM_RD_MOD Specifications</i> on the next page.	Subcommand	Cannot be used
3		STATUS	<ul style="list-style-type: none"> Reads the following alarm and warning status. <ul style="list-style-type: none"> Current alarm/warning status Alarm history* (Warnings and communications alarms A.E50 and A.E60 will not be read out since they are not preserved in the history.) Refer to the following section for the specifications for ALM_RD_MOD. <ul style="list-style-type: none">  <i>ALM_RD_MOD Specifications</i> on page 3-21 Alarm and warning codes are set in ALM_DATA from byte 6 in order from the most recent, and 0 is set in the bytes that are blank. Accordingly, the data in byte 6 is the latest alarm or warning code. A warning will occur and the command will be ignored in the following cases. <ul style="list-style-type: none"> If ALM_RD_MOD is out of the range: A.94B alarm (Data Setting Warning 2) 			
4						
5	ALM_RD_MOD	ALM_RD_MOD				
6	-	ALM_DATA				
7						
8						
9						
10						
11						
12						
13						
14						
15						
16	WDT	RWDT				

* Alarm history is saved in the non-volatile memory, and will not be lost if the control power goes OFF.

ALM_RD_MOD Specifications

ALM_RD_MOD	Description	Processing Time			
0	Read current alarm/warning status 10 items max. (sixth to fifteenth byte)	Within communications cycle			
1	Read alarm history (warnings and communications alarms A.E50 and A.E60 are not preserved in the history.) 10 records max. (sixth to fifteenth byte)	Within 60 ms			
2	Gets the detailed information of current alarm or warning one by one. Set the occurrence order from 0 (the latest) to 9 for the alarm index.	Within 12 ms			
			Byte	Command	Response
			6	Alarm index	Alarm index
			7	0	Alarm code
8	0				
3	Gets the detailed information of alarm history one by one. Set the occurrence order from 0 (the latest) to 9 for the alarm index.	Within 12 ms			
			Byte	Command	Response
			6	Alarm index	Alarm index
			7	0	Alarm code
8	0				

■ When ALM_RD_MOD=0 or 1

An alarm code of 1-byte length is returned.

Example The A.960 alarm (MECHATROLINK Communications Warning) occurred and then, the A.E61 alarm (MECHATROLINK Transmission Cycle Error) occurred.

1) Current warning/alarm (ALM_RD_MOD = 0)

Byte	ALM_DATA
6	E6 hex
7	96 hex
8	0
⋮	
⋮	
⋮	
⋮	
⋮	
15	

Index 0
Index 1
↓
Warnings will not be shown.
Index 9

2) Alarm history (ALM_RD_MOD = 1)

Byte	ALM_DATA
6	E6 hex
n-1	
n	
n+1	
⋮	
15	

Index 0 } Latest alarm
Index n } Earlier alarms
Index 9 }

Example

- The current warning or alarm status can be cleared by executing the ALM_CLR (ALM_CLR_MOD = 0) command.
- The alarm history will not be cleared until the ALM_CLR(ALM_CLR_MOD = 1) command is executed.

■ When ALM_RD_MOD = 2 or 3

An alarm code of 2-byte length is returned.

If ALM_RD_MOD is set to 2 in the above example, the following alarm codes will be read out.
0xE61 for alarm index 0, and
0x960 for alarm index 1

3.1.16 ALM_CLR (Clear Warnings and Alarms) Command: 06 Hex

This command clears the current alarms and warnings and the alarm history.

ALM_CLR Command

The specifications of the ALM_CLR command are described below.

Byte	ALM_CLR		Description			
	Command	Response				
1	06 hex	06 hex	Phases in which the command can be executed	Phase 2 and 3	Synchronization classification	Asynchronous command
2	-	ALARM	Processing time	See (2) ALM_CLR_MOD Specifications.	Subcommand	Cannot be used
3		STATUS	<ul style="list-style-type: none"> Clears the followings. <ul style="list-style-type: none"> Current alarm/warning status Alarm history * A warning will occur and the command will be ignored in the following cases. <ul style="list-style-type: none"> When using SigmaWin or a digital operator to execute utility functions: A.95A alarm (Command Warning 1) ALM_CLR_MOD is out of the setting range: A.94B alarm (Data Setting Warning 2) The alarm status will not be cleared in the following cases. <ul style="list-style-type: none"> An alarm that cannot be reset occurs. An alarm that cannot be reset occurs but the cause of the alarm has not yet been removed. 			
4						
5	ALM_CLR_MOD	ALM_CLR_MOD		-	-	
6						
7						
8						
9						
10						
11						
12						
13						
14						
15						
16	WDT	RWDT				

* Alarm history is saved in the non-volatile memory, and will not be lost if the control power goes OFF.

ALM_CLR_MOD Specifications

ALM_CLR_MOD	Description	Processing Time
0	Clears current alarm/warning status.	Within 200 ms
1	Clears alarm history.	Within 2 s

3.1.17 POS_SET (Set Coordinate System) Command: 20 Hex

This command sets the position coordinate system.

POS_SET Command

The specifications of the POS_SET command are described below.

Byte	POS_SET		Description			
	Command	Response				
1	20 hex	20 hex	Phases in which the command can be executed	Phase 2 and 3	Synchronization classification	Asynchronous command
2	-	ALARM	Processing time	Within communications cycle	Subcommand	Cannot be used
3		STATUS	<ul style="list-style-type: none"> Sets the current position to the position specified by POS_DATA. The origin (ZPOINT) and software limit settings are enabled by setting a reference point. Refer to the following section for the specifications for PS_SUBCMD. <ul style="list-style-type: none">  PS_SUBCMD Specifications on page 3-23 Specify the position (coordinates) in POS_DATA. A warning will occur and the command will be ignored in the following cases. <ul style="list-style-type: none"> A number out of the range is set in PS_SUBCMD: A.94B alarm (Data Setting Warning 2) 			
4						
5	PS_SUBCMD	PS_SUBCMD				
6	POS_DATA	POS_DATA				
7						
8						
9						
10						
11	-	-				
12						
13						
14						
15						
16	WDT	RWDT				

PS_SUBCMD Specifications

D7	D6	D5	D4	D3	D2	D1	D0
REFE	0	0	0	POS_SEL			

■ REFE (Reference Point Setting)

0: Does not set reference point.

1: Sets reference point. The coordinates will be determined and the zero point position (ZPOINT) and software limit setting will be enabled.

■ POS_SEL (Coordinate system selection)



3: Sets APOS (feedback position in machine coordinate system), and sets the positions of all coordinate systems (TPOS, IPOS, POS, MPOS, APOS) to POS_DATA.

3.1.18 ADJ (Monitor and Adjust Settings) Command: 3E Hex

This command is used to monitor and adjust settings.

ADJ Command

The specifications of the ADJ command are described below.

Byte	ADJ		Description			
	Command	Response				
1	3E hex	3E hex	Phases in which the command can be executed	Phase 2 and 3	Synchronization classification	Asynchronous command
2	SUB-CODE=01	ALARM	Processing time	Depends on processing	Subcommand	Cannot be used
3	-	STATUS	<ul style="list-style-type: none"> Use this command as SUBCODE = 01 hex. The SERVOPACK will be in maintenance mode. And, data monitoring and adjustment will be enabled. Refer to the following section for details on using the ADJ command for adjustments. <ul style="list-style-type: none">  <i>How to Send an ADJ Command for Adjustment on page 3-24</i> Refer to the following section for details on using the ADJ command to monitor data. <ul style="list-style-type: none">  <i>How to Send an ADJ Command for Monitoring Data on page 3-26</i> A warning will occur and the command will be ignored in the following cases. <ul style="list-style-type: none"> While editing using SigmaWin or digital operator: A.95A alarm (Command Warning 1) CADDRESS is out of the range: A.94A alarm (Data Setting Warning 1) CSIZE does not match: A.94D alarm (Data Setting Warning 4) CCMD and/or CDATA are out of the range: A.94B alarm (Data Setting Warning 2) 			
4						
5	CCMD	CANS				
6						
7	CADDRESS	CADDRESS				
8						
9	CSIZE	CSIZE/ERRCODE				
10						
11	CDATA	RDATA				
12						
13						
14						
15	WDT	RWDT				
16						

How to Send an ADJ Command for Adjustment

The table below lists the adjustments that can be executed by sending an ADJ command.

Adjustment	Request Code	Preparation Before Execution	Processing Time	Execution Conditions
Normal mode	0000 hex	None	200 ms max.	-
Parameter initialization	1005 hex	None	20 s max.	Initialization is impossible while the servo is ON. After initialization, the power supply must be turned OFF and then ON again.
Absolute encoder reset	1008 hex	Required	5 s max.	When using an incremental encoder, it is impossible to reset the encoder while the servo is ON. After initialization, the power supply must be turned OFF and then ON again.

Continued on next page.

Continued from previous page.

Adjustment	Request Code	Preparation Before Execution	Processing Time	Execution Conditions
Automatic offset adjustment of motor current detection signals	100E hex	None	5 s max.	Adjustment is disabled: <ul style="list-style-type: none"> • While the main circuit power supply is OFF • While the servo is ON • While the servomotor is running
Multiturn limit setting	1013 hex	Required	5 s max.	When using an incremental encoder, the setting is disabled unless A.CC0 (Multiturn Limit Disagreement) occurs. After initialization, the power supply must be turned OFF and then ON again.

Details of Command for Adjustment to Monitor Data

	Command	Response
CCMD/CANS	CCMD = 04 hex	CANS = 04 hex (copy of the command)
CADDRESS	Setting address	Reference address (copy of the command)
CSIZE/ERRCODE	2 or 4	At normal reception: 0000 hex At error occurrence: A value other than 0
CDATA/RDATA	Setting data	Setting data (copy of the command)

1. Send the following data and set the request code of the adjustment to be executed.

CCMD = 0004 hex

CADDRESS = 2000 hex

CSIZE = 0002 hex

CDATA = Request code of the adjustment to be executed

STATUS.CMDRDY is set to 1 when execution is completed. Use this to confirm completion. Also check ERRCODE. If an error occurs, carry out the operation in step 4 to abort execution.

2. For adjustment that requires a preparation process, send the following data.

CCMD = 0004 hex

CADDRESS = 2001 hex

CSIZE = 0002 hex

CDATA = 0002 hex

STATUS.CMDRDY is set to 1 when execution is completed. Use this to confirm completion. Also check ERRCODE. If an error occurs, carry out the operation in step 4 to abort execution.

3. Send the following data to execute adjustment.

CCMD = 0004 hex

CADDRESS = 2001 hex

CSIZE = 0002 hex

CDATA = 0001 hex

STATUS.CMDRDY is set to 1 when execution is completed. Use this to confirm completion. Also check ERRCODE. If an error occurs, carry out the operation in step 4 to abort execution.

4. Send the following data to abort the execution.

CCMD = 0004 hex

CADDRESS = 2000 hex

CSIZE = 0002 hex

CDATA = 0000 hex

STATUS.CMDRDY is set to 1 when execution is completed. Use this to confirm completion.

Example

If an A.E50 alarm (MECHATROLINK Synchronization Error) or A.E60 alarm (MECHATROLINK Communications Error) occurs after the request code has been set for step 1 and before adjustment has been executed for step 3, the adjustment operation cannot be performed. If an alarm occurs, remove the cause of the alarm and then restart the adjustment operation.

How to Send an ADJ Command for Monitoring Data

The table below lists the data that can be monitored.

List of Data that Can be Monitored

Name	Reference Address	Data Size	Unit	Remarks
Motor capacity	C00F hex (Lowermost) C010 hex (Uppermost)	2 bytes	[W]	
Motor voltage	C011 hex	2 bytes	[V]	
Motor rated speed	C01C hex	2 bytes	Rotary motor: $[\times 10^{C01E \text{ hex reference value}} \text{ min}^{-1}]$ Linear motor: $[\times 10^{C01E \text{ hex reference value}} \text{ mm/s}]$	
Maximum motor speed	C01D hex	2 bytes	Rotary motor: $[\times 10^{C01E \text{ hex reference value}} \text{ min}^{-1}]$ Linear motor: $[\times 10^{C01E \text{ hex reference value}} \text{ mm/s}]$	
Motor speed exponent	C01E hex	2 bytes	–	
Motor rated torque	C01F hex	2 bytes	Rotary servomotor: $[\times 10^{C021 \text{ hex reference value}} \text{ N}\cdot\text{m}]$ Linear servomotor: $[\times 10^{C021 \text{ hex reference value}} \text{ N}]$	
Motor torque exponent	C021 hex	2 bytes	–	
Encoder resolution	C022 hex (Lowermost) C023 hex (Uppermost)	2 bytes	Rotary servomotor: [pulse/rev] Linear servomotor: [pulse/pitch]	Note: When fully-closed setting is enabled (Pn002.3≠0), the unit is pulse/pitch.
Maximum motor torque that can be output	E701 hex	2 bytes	[%]	
Motor max. output speed	C027 hex	2 bytes	Rotary servomotor: $[\times 10^{C01E \text{ hex reference value}} \text{ min}^{-1}]$ Linear servomotor: $[\times 10^{C01E \text{ hex reference value}} \text{ mm/s}]$	
Linear scale pitch	E084 hex	4 bytes	$[\times 10^{E086 \text{ hex reference value}} \text{ }\mu\text{m / pitch}]$	For linear servomotors only
Linear scale pitch exponent	E086 hex	2 bytes	–	For linear servomotors only

Information The following data units are used for position, speed, and torque control that is performed with commands.

Speed data: Maximum motor speed/40000000 hex (VREF and VLIM)

Torque data: TFF, P_TLIM, N_TLIM, and TLIM: Maximum motor torque/4000 hex

TQREF: Maximum motor torque/40000000 hex

You can determine the maximum motor speed and maximum motor torque using the above units with the following formulas.

Maximum motor speed = C027 hex reference value $\times 10^{C01E \text{ hex reference value}}$ [Rotary Servomotor: min^{-1} , Linear Servomotor: mm/s]

Maximum motor torque = C01F hex reference value $\times 10^{E701 \text{ hex reference value}}$ [Rotary Servomotor: N·m, Linear Servomotor: N]

Details of Command to Monitor Data

	Command	Response
CCMD/CANS	CCMD = 03 hex	CANS = 03 hex (copy of the command)
CADDRESS	Reference address	Reference address (copy of the command)
CSIZE/ ERRCODE	– (Not required)	At normal reception: SIZE (2 or 4) At error occurrence: A value other than 2 and 4
CDATA/RDATA	– (Not required)	Reference data

1. Set the reference address to be monitored, and send the ADJ command.
 CCMD = 0003 hex
 CADDRESS = Reference address
 STATUS.CMDRDY is set to 1 when execution is completed. Use this to confirm completion. Use
 ERRCODE to check for errors.
2. When the command transmission is completed normally, CDATA of RSP will be read out
 for CSIZE to obtain the data.

3.2 Motion Commands

3.2.1 HOLD (Stop Motion) Command: 25 Hex

HOLD Command

The HOLD command is used to perform a deceleration to stop from the current run status, at a deceleration ratio specified by the parameter for positioning.

Byte	HOLD		Description			
	Command	Response				
1	25 hex	25 hex	Phases in which the command can be executed	Phase 2 and 3	Synchronization classification	Asynchronous command
2	-	ALARM	Processing time	Within communications cycle	Subcommand	Cannot be used
3	OPTION	STATUS	<ul style="list-style-type: none"> From the current state, performs a stop specified by the HOLD_MOD command. Use DEN (output complete) to confirm position data output completion. Option field can be used. This command will cancel the latch processing specified by the LATCH or EX_POSING command. This command will cancel ZRET latch processing and ZRET origin return processing. Upon completion of execution of this command, the reference position (POS) must be read, and the controller coordinate system must be setup. The stopping method can be selected using HOLD_MOD. 0 = Stop according to the 1st or 2nd linear deceleration constant. 1 = Stop immediately (stop reference output) 2 = Stop according to the linear deceleration constant for stopping 			
4						
5	HOLD_MOD	MONITOR1				
6	-					
7						
8						
9						
10						
11		MONITOR2				
12						
13	SEL_MON1/2	SEL_MON1/2				
14	-	IO_MON				
15						
16	WDT	RWDT				
17	Subcommand area	Subcommand area				
18						
19						
20						
21						
22						
23						
24						
25						
26						
27						
28						
29						

Related Parameters

Deceleration is specified by the following parameters.

Parameter No.	Name
Pn80D (Pn83A*)	First Stage Linear Deceleration Constant (First Stage Linear Deceleration Constant 2)
Pn80E (Pn83C*)	Second Stage Linear Deceleration Constant (Second Stage Linear Deceleration Constant 2)
Pn80F (Pn83E*)	Deceleration Constant Switching Speed (Deceleration Constant Switching Speed 2)
Pn827 (Pn840*)	Linear Deceleration Constant 1 for Stopping (Linear Deceleration Constant 2 for Stopping)

* Parameters in parentheses are used when Pn833 is set to 1.

3.2.2 LTMOD_ON (Set Latch Mode) Command: 28 Hex

LTMOD_ON Command

The LTMOD_ON command is used to start latching the external signal input position data. Execution on the LTMOD_ON command allows latch operation while a command such as POSING and VELCTRL is being executed.

Byte	LTMOD_ON		Description			
	Command	Response				
1	28 hex	28 hex	Phases in which the command can be executed	Phase 2 and 3	Synchronization classification	Asynchronous command
2	LT_SGNL	ALARM	Processing time	Within communications cycle	Subcommand	Can be used
3	-	STATUS	<ul style="list-style-type: none"> Starts latch operation. Use LT_MOD to switch the latch mode: <ul style="list-style-type: none"> = 0: Normal latch mode (Latches the position data when a signal selected by LT_SGNL is input) = 1: Continuous latch (Latches the position data according to the values set in Pn850 to Pn853) Note: When LT_MOD ≠ 1, the normal latch mode is always selected. When CMDRDY = 1, this command has been received. L_CMP in STATUS is set to 1 when the latch is completed. Use this to confirm completion. When there is monitor data such as SMON and POSING appended to the command response, LPOS is forcefully returned to MONITOR 2 for one communications cycle. When there is no monitor data such as PRM_RD or ALM_RD appended to the command response, confirm that L_CMP of status field is set 1, then use a command that has monitor data such as SMON in the response and select LPOS to confirm. A warning will occur and the command will not be executed. <ul style="list-style-type: none"> Interference with another latch mode command (If this command is sent while another latch mode command such as EX_POSING, LATCH, ZRET, and SVCTRL is being executed): A.95D alarm (Command Warning 4) LT_MOD = 1 and Pn850 = 0: A.94E alarm (Data Setting Warning 5) Latch time lag <ul style="list-style-type: none"> From reception of the command to latching start: 250ms max. From completion of latching to transmission of a response: One communications cycle max. 			
4						
5	LT_MOD	MONITOR1				
6	-					
7						
8						
9		-				
10						
11						
12						
13	SEL_MON1/2	SEL_MON1/2				
14	-	IO_MON				
15						
16	WDT	RWDT				
17	Subcommand area	Subcommand area				
18						
19						
20						
21						
22						
23						
24						
25						
26						
27						
28						
29						

Normal Latch Mode

In normal latch mode, the latch operation is started by sending an LTMOD_ON command, and it is completed when the input position of the latch signal LT_SGNL specified in the LTMOD_ON command is latched

To restart the latch operation, send the LTMOD_OFF command once, then send the LTMODE_ON command again. Use LT_MOD in the LTMOD_ON command to select either normal or continuous latch mode.

Continuous Latch Mode

This function sequentially latches the input positions of sequence signal 1 to sequence signal n ($n = 1$ to 8) for a specified number of times. The continuous latch operation can be aborted by executing the LTMOD_OFF command. This function can shorten the time between latch completion and the start of the next latch, and enables sequential latch operations at high speed.

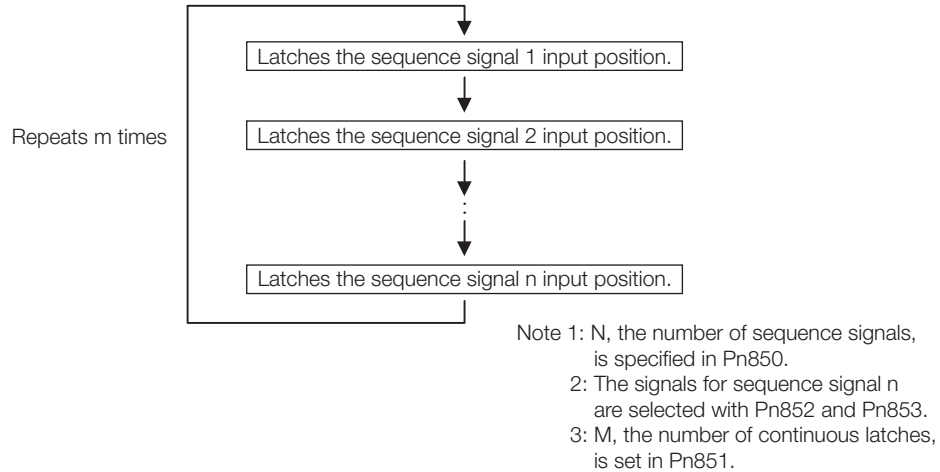

■ How to Start and Stop Continuous Latch Operation

Set the following parameters, and then set LT_MOD to 1 to execute the LTMOD_ON command. The continuous latch operation will start. To abort the operation, execute the LTMOD_OFF command.

Pn850: Number of Latch Sequences n

Pn851: Continuous Latch Sequence Count m (When $m = 0$, the continuous latch operation will be infinitely repeated.)

Pn852: Latch Sequence 1 to 4 Settings

Pn853: Latch Sequence 5 to 8 Settings

Note: If the LTMOD_ON command is executed by setting Pn850 to 0 and LT_MOD to 1, the (A.94E alarm (Data Setting Warning 5 (Latch Mode Error)) will occur and the latch operation will not start.

■ Latch Status

Latch completion can be confirmed by the following status.

• STATUS Field: The 3rd and 4th byte

L_CMP (D10): L_CMP is set to 1 for one communications cycle every time the external signal is input.

• EX_STATUS Field: The 28th and 29th byte

L_SEQ_NO (D8-D11): The latch sequence signal number (value n) at latch completion

L_CMP_CNT (D0-D7): The continuous latch count (value m)

(Added at completion of position latch when the latch sequence signal n is input.)

Note: LPOS is forcibly output to MONITOR 2 for one communications cycle while L_CMP = 1 every time the external signal is input.

■ Latched Position Data

The latest latched position data at completion of latching can be obtained by using the following monitor.

Name	Code	Remarks
Feedback Latch Position	LPOS	The latest latch signal input position

The previously latched position data can be obtained by using the following option monitor.

Name	Code	Option Monitor Selection (Pn824 and Pn825)
Option Monitor 1 and 2	OMN1, 2	80 hex: Previous latch signal input position

Related Parameters

The parameters related to latch operation are listed below.

Parameter No.	Name
Pn820	Forward Latching Area
Pn822	Reverse Latching Area
Pn850	Number of Latch Sequences
Pn851	Continuous Latch Sequence Count
Pn852 and Pn853	Latch Sequence 1 to 4 Settings and Latch Sequence 5 to 8 Settings

Information

- EXT1, EXT2, and EXT3 signals must be assigned as the input signals of CN1 by using the parameter Pn511. If they are not assigned, the latch operation will be undefined.
- If encoders without phase C (origin signal) and linear scales are used and the phase C is selected, the latch operation will be undefined.

3.2.3 LTMOD_OFF (Release Latch Mode) Command: 29 Hex

LTMOD_OFF Command

The LTMOD_OFF command is used to release the latch mode.

Byte	LTMOD_OFF		Description			
	Command	Response				
1	29 hex	29 hex	Phases in which the command can be executed	Phase 2 and 3	Synchronization classification	Asynchronous command
2	-	ALARM	Processing time	Within communications cycle	Subcommand	Can be used
3		STATUS	<ul style="list-style-type: none"> Check that CMDRDY is 1 to confirm that this command has been received. It takes 250 μs max. to release the latch mode. This command cannot be used while LATCH, ZRET, EX_POSING, or SVCTRL command is being executed. If used, an A.95D alarm (Command Warning 4) will occur.			
4		MONITOR1				
5						
6						
7						
8						
9						
10						
11						
12		MONITOR2				
13		SEL_MON1/2		SEL_MON1/2		
14	-	IO_MON				
15						
16	WDT	RWDT				
17	Subcom- mand area	Subcom- mand area				
18						
19						
20						
21						
22						
23						
24						
25						
26						
27						
28						
29						

3.2.4 INTERPOLATE (Interpolation Feeding) Command: 34 Hex

INTERPOLATE Command

The INTERPOLATE command is used to start interpolation feeding. Speed feed forward and torque feed forward can be specified simultaneously.

Byte	INTERPOLATE		Description			
	Command	Response				
1	34 hex	34 hex	Phases in which the command can be executed	Phase 3	Synchronization classification	Synchronous command
2	–	ALARM	Processing time	Within communications cycle	Subcommand	Can be used
3	OPTION	STATUS	<ul style="list-style-type: none"> OPTION field can be selected. Interpolation feeding is performed by specifying the target position (TPOS) every communications cycle. The target position (TPOS) is a signed 4-byte data. Note: The target position is not an incremental value (travel amount), but the absolute position in the reference coordinate system. The speed feed forward (VEF [reference units/s]) is a signed 4-byte data. Either torque feed forward (TFF) or torque limit (TLIM) can be used. It can be selected by setting Pn81F and Pn002. <ul style="list-style-type: none"> TFF setting range: A signed 2-byte data [maximum motor torque/4000 hex] Use the ADJ command to obtain the maximum motor torque. TLIM setting range: 0 to 4000 hex [maximum motor torque/4000 hex] (If a value between 4000 hex and FFFF hex is set, the maximum motor torque will be applied as the limit. Use DEN (output complete) to confirm the completion of position reference output. When a command in execution is switched to another command, the feed forward value (VFF or TFF) will be cleared. A warning will occur and the command will not be executed in the following cases. <ul style="list-style-type: none"> If this command is used in communications phase other than phase 3: A.95A alarm (Command Warning 1) If this command is sent while the servo is OFF: A.95A alarm (Command Warning1) The travel amount (Target position (TPOS) - Current position (IPOS)) exceeds the limit value: A.94B alarm (Data Setting Warning 2) When using SigmaWin or a digital operator for motor operations such as JOG: A.95A alarm (Command Warning 1) 			
4						
5	TPOS	MONITOR1				
6						
7						
8						
9	VFF	MONITOR2				
10						
11						
12						
13	SEL_MON1/2	SEL_MON1/2				
14	TFF/TLIM	IO_MON				
15						
16	WDT	RWDT				
17	Subcommand area	Subcommand area				
18						
19						
20						
21						
22						
23						
24						
25						
26						
27						
28						
29						

Related Parameters

Either torque feed forward (TFF) or torque limit (TLIM) can be selected by setting the following parameters.

Parameter No.	Set Value	Meaning
Pn81F	n.□□1□	Enables the torque feed forward (TFF).
Pn002	n.□□□2	
Pn81F	n.□□1□	Enables forward/reverse torque limit using TLIM.
Pn002	n.□□□1	
Pn81F	n.□□1□	When P_CL of OPTION field is set to 1: Uses TLIM as positive torque limit. When N_CL of OPTION field is set to 1: Uses TLIM as negative torque limit.
Pn002	n.□□□3	

3.2.5 POSING (Positioning) Command: 35 Hex

POSING Command

The POSING command is used to start positioning to the target position (TPOS) at the target speed (TSPD).

Byte	POSING		Description			
	Command	Response				
1	35 hex	35 hex	Phases in which the command can be executed	Phase 2 and 3	Synchronization classification	Asynchronous command
2	-	ALARM	Processing time	Within communications cycle	Subcommand	Can be used
3	OPTION	STATUS	<ul style="list-style-type: none"> OPTION field can be selected. The target position (TPOS) is a signed 4-byte data. It is sent by using an absolute position in the reference coordinate system. Set the target position (TPOS) so that the movement distance (TPOS - IPOS) is 2,147,483,647 (= $2^{31}-1$) or less. Set the target speed (TSPD) to a value between 0 and the motor max. speed [reference unit/s]. Changes can be made to the target position and target speed during movement. The torque limit (TLIM) can be used by setting Pn81F and Pn002. TLIM setting range: 0 to 4000 hex [maximum motor torque/4000 hex] If TLIM is set to a value between 4000 hex and FFFF hex, the maximum motor torque will be applied as the limit. Use the ADJ command to obtain the maximum motor torque. Use DEN (output complete) to confirm the completion of position reference output. A warning will occur and the command will be ignored in the following case. <ul style="list-style-type: none"> This command is used while the servo is OFF: A.95A alarm (Command Warning 1) The target speed (TSPD) exceeds the limit: A.94B alarm (Data Setting Warning 2) When using SigmaWin or a digital operator for motor operations such as JOG: A.95A alarm (Command Warning 1) 			
4						
5	TPOS	MONITOR1				
6						
7						
8						
9	TSPD	MONITOR2				
10						
11						
12						
13	SEL_MON1/2	SEL_MON1/2				
14	TLIM	IO_MON				
15						
16	WDT	RWDT				
17	Subcom- mand area	Subcom- mand area				
18						
19						
20						
21						
22						
23						
24						
25						
26						
27						
28						
29						

Positioning will be performed as illustrated below.

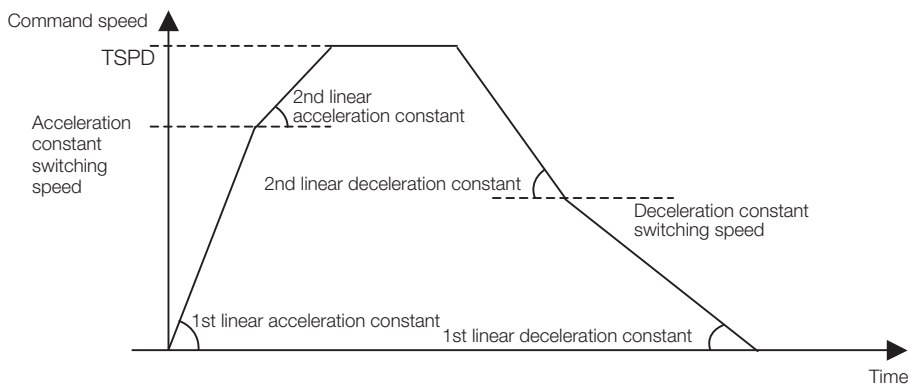

Related Parameters

The parameters related to this command are listed below.

Parameter No.	Name
Pn80A (Pn834*)	First Stage Linear Acceleration Constant (First Stage Linear Acceleration Constant 2)
Pn80B (Pn836*)	Second Stage Linear Acceleration Constant (Second Stage Linear Acceleration Constant 2)
Pn80C (Pn838*)	Acceleration Constant Switching Speed (Acceleration Constant Switching Speed 2)
Pn80D (Pn83A*)	First Stage Linear Deceleration Constant (First Stage Linear Deceleration Constant 2)
Pn80E (Pn83C*)	Second Stage Linear Deceleration Constant (Second Stage Linear Deceleration Constant 2)
Pn80F (Pn83E*)	Deceleration Constant Switching Speed (Deceleration Constant Switching Speed 2)
Pn81F = n.□□X□	Position Control Command TFF/TLIM Allocation
Pn002 = n.□□□X	MECHATROLINK Command Position and Speed Control Option

* Parameters in parentheses are used when Pn833 is set to 1.

Set the parameters as shown below to use TLIM.

Parameter No.	Set Value	Meaning
Pn81F	n.□□1□	Enables forward/reverse torque limit using TLIM.
Pn002	n.□□□1	
Pn81F	n.□□1□	When P_CL of OPTION field is set to 1: Uses TLIM as positive torque limit. When N_CL of OPTION field is set to 1: Uses TLIM as negative torque limit
Pn002	n.□□□3	

3.2.6 FEED (Constant Speed Feeding) Command: 36 Hex

FEED Command

The FEED command is used to start constant speed feeding at the specified target speed (TSPD) by position control.

Use the HOLD (Stop Motion) command to stop constant-speed feeding that is being executed for this command.

Byte	FEED		Description					
	Command	Response						
1	36 hex	36 hex	Phases in which the command can be executed	Phase 2 and 3	Synchronization classification	Asynchronous command		
2	-	ALARM	Processing time	Within communications cycle	Subcommand	Can be used		
3	OPTION	STATUS	<ul style="list-style-type: none"> OPTION field can be selected. The target speed (TSPD) is a signed 4-byte data. The feeding direction is determined by the sign. Constant speed feeding is carried out at the specified target speed. TSPD setting range: Negative (-) maximum motor speed to positive (+) maximum motor speed [reference unit/s] Changes can be made to the target speed during movement. Change the target speed as required and send this command. The torque limit (TLIM) can be used by setting Pn81F and Pn002. <ul style="list-style-type: none"> TLIM setting range: 0 to 4000 hex [maximum motor torque/4000 hex] If TLIM is set to a value between 4000 hex and FFFF hex, the maximum motor torque will be applied as the limit. Use the ADJ command to obtain the maximum motor torque. Use the DEN (output complete) to confirm the completion of position reference output. A warning will occur and the command will not be executed in the following cases. <ul style="list-style-type: none"> The command is used while the servo is OFF: A.95A alarm (Command Warning 1) The target speed (TSPD) exceeds the limit: A.94B alarm (Data Setting Warning 2) When using SigmaWin or a digital operator for motor operations such as JOG: A.95A alarm (Command Warning 1) 					
4								
5								
6	-	MONITOR1						
7								
8								
9								
10	TSPD	MONITOR2						
11								
12								
13	SEL_MON1/2	SEL_MON1/2						
14	TLIM	IO_MON						
15								
16	WDT	RWDT						
17	Subcommand area	Subcommand area						
18								
19								
20								
21								
22								
23								
24								
25								
26								
27								
28								
29								

Constant speed feeding is performed as illustrated below.

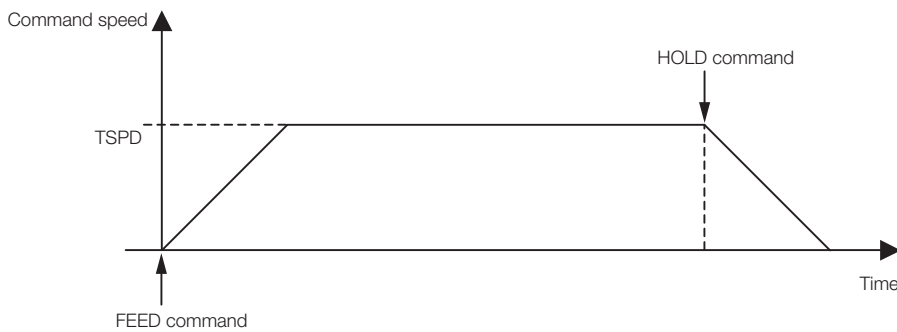

Related Parameters

The parameters related to this command are listed below.

Parameter No.	Name
Pn80A (Pn834*)	First Stage Linear Acceleration Constant (First Stage Linear Acceleration Constant 2)
Pn80B (Pn836*)	Second Stage Linear Acceleration Constant (Second Stage Linear Acceleration Constant 2)
Pn80C (Pn838*)	Acceleration Constant Switching Speed (Acceleration Constant Switching Speed 2)
Pn81F = n.□□X□	Position Control Command TFF/TLIM Allocation
Pn002 = n.□□□X	MECHATROLINK Command Position and Speed Control Option

* Parameters in parentheses are used when Pn833 is set to 1.

Set the parameters as shown below to use TLIM.

Parameter No.	Set Value	Meaning
Pn81F	□□1□	Enables torque limit (TLIM).
Pn002	n.□□□1	
Pn81F	n.□□1□	When P_CL of OPTION field is set to 1: Uses TLIM as positive torque limit.
Pn002	n.□□□3	When N_CL of OPTION field is set to 1: Uses TLIM as negative torque limit.

3.2.7 LATCH (Interpolation Feeding with Position Detection) Command: 38 Hex

LATCH Command

The LATCH command is used to start interpolation feeding and to latch the current position when the external signal is input during positioning.

Speed feed forward, torque feed forward, and torque limit can be applied.

Byte	LATCH		Description			
	Command	Response				
1	38 hex	38 hex	Phases in which the command can be executed	Phase 3	Synchronization classification	Synchronous command
2	LT_SGNL	ALARM	Processing time	Within communications cycle	Subcommand	Can be used
3	OPTION	STATUS	<ul style="list-style-type: none"> Use LT_SGNL to select the latch signal. Refer to the following section for details on LT_SGNL. ☞ 2.1.6 LT_SGNL Specifications on page 2-7 The position data when the latch signal is input is stored in the feedback latch position (LPOS) and is forcibly output to MONITOR2 for one communications cycle. OPTION field can be used. Interpolation feeding is performed by specifying the target position (TPOS) every communications cycle. The target position (TPOS) is a signed 4-byte data. Note: The target position is not an incremental value (travel amount), but the absolute position in the reference coordinate system. The speed feed forward (VEF [reference units/s]) is a signed 4-byte data. Either torque feed forward (TFF) or torque limit (TLIM) can be used. It can be selected by setting Pn81F and Pn002. <ul style="list-style-type: none"> TLIM setting range: 0 to 4000 hex [maximum motor torque/4000 hex] (If a value between 4000 hex and FFFF hex is set, the maximum motor torque will be applied as the limit.) Use the ADJ command to obtain the maximum motor torque. TFF setting range: A signed 2-byte data [maximum motor torque/4000 hex] Use DEN (output complete) to confirm the completion of position reference output. When a command in execution is switched to another command, the feed forward values (VFF and TFF) will be cleared. A warning will occur and the command will not be executed in the following cases. <ul style="list-style-type: none"> The command is used in a phase other than phase 3: A.95A alarm (Command Warning 1) The command is sent while the servo is OFF: A.95A alarm (Command Warning 1) The travel amount (Target position (TPOS) - Current position (IPOS)) exceeds the limit: A.94B alarm (Data Setting Warning 2) When using SigmaWin or a digital operator for motor operations such as JOG: A.95A alarm (Command Warning 1) Latch time lag <ul style="list-style-type: none"> From reception of the command to latching start: 250 μs max. From completion of latching to transmission of a response: One communications cycle max. 			
4						
5	TPOS	MONITOR1				
6						
7						
8						
9	VFF	MONITOR2				
10						
11						
12						
13	SEL_MON1/2	SEL_MON1/2				
14	TFF/TLIM	IO_MON				
15						
16	WDT	RWDT				
17	Subcom- mand area	Subcom- mand area				
18						
19						
20						
21						
22						
23						
24						
25						
26						
27						
28						
29						

Related Parameters

The parameters related to the execution of LATCH command are listed below.

Parameter No.	Name
Pn820	Forward Latching Area
Pn822	Reverse Latching Area
Pn81F = n.□□X□	Position Control Command TFF/TLIM Allocation
Pn002 = n.□□□X	MECHATROLINK Command Position and Speed Control Option

Either torque feed forward (TFF) or torque limit (TLIM) can be selected by setting the following parameters.

Parameter No.	Set Value	Meaning
Pn81F	n.□□1□	Enables the torque feed forward (TFF).
Pn002	n.□□□2	
Pn81F	n.□□1□	Enables forward/reverse torque limit using TLIM.
Pn002	n.□□□1	
Pn81F	n.□□1□	When P_CL of OPTION field is set to 1: Uses TLIM as positive torque limit. When N_CL of OPTION field is set to 1: Uses TLIM as negative torque limit.
Pn002	n.□□□3	

3.2.8 EX_POSING (External Input Positioning) Command: 39 Hex

EX_POSING Command

The EX_POSING command is used to start positioning to the target position (TPOS) at the target speed (TSPD). When a latch signal is input midway, positioning is performed according to the final travel distance for external positioning from the latch signal input position. When no latch signal is input, positioning is performed for the target position (TPOS).

Byte	EX_POSING		Description			
	Command	Response				
1	39 hex	39 hex	Phases in which the command can be executed	Phase 2 and 3	Synchronization classification	Asynchronous command
2	LT_SGNL	ALARM	Processing time	Within communications cycle	Subcommand	Can be used
3	OPTION	STATUS	<ul style="list-style-type: none"> Use LT_SGNL to select the latch signal. Refer to the following section for details on LT_SGNL. ☞ 2.1.6 LT_SGNL Specifications on page 2-7 When the latch signal is input, positioning is performed according to the final travel distance for external positioning specified in Pn814 from the latch signal input position. And, the latch signal input position is stored in the feedback latch position (LPOS) and is forcibly output to MONITOR2 for one communications cycle. When no latch signal is input, positioning is performed for the specified target position (TPOS). OPTION field can be used. The target position (TPOS) is a signed 4-byte data, and the absolute position in reference coordinate system. Set the target position (TPOS) so that the travel distance (TPOS - IPOS) is a value of 31 bits (24...) or less. The target speed (TSPD) is an unsigned 4-byte data. You can specify between 0 and the maximum motor speed [reference units/s]. The target position and target speed can be changed during positioning executed by this command. However, any change in the target position and/or target speed after the latch signal input will be invalid. The torque limit (TLIM) can be used by setting Pn81F and Pn002. <ul style="list-style-type: none"> TLIM setting range: 0 to 4000 hex [maximum motor torque/4000 hex] If a value between 4000 hex and FFFF hex is set, the maximum motor torque will be applied as the limit. Use the ADJ command to obtain the maximum motor torque. Use DEN (output complete) to confirm the completion of position reference output. When the command in execution is switched from this command to another command, latching will be cancelled and positioning will be performed for the specified target position (TPOS). A warning will occur and the command will not be executed in the following cases. <ul style="list-style-type: none"> This command is used when the servo is OFF: A.95A alarm (Command Warning 1) The target speed (TSPD) exceeds the limit: A.94B alarm (Data Setting Warning 2) When using SigmaWin or a digital operator for motor operations such as JOG: A.95A alarm (Command Warning 1) 			
4						
5	TPOS	MONITOR1				
6						
7						
8						
9	TSPD	MONITOR2				
10						
11						
12						
13	SEL_MON1/2	SEL_MON1/2				
14	TLIM	IO_MON				
15						
16						
17	Subcom- mand area	Subcom- mand area				
18						
19						
20						
21						
22						
23						
24						
25						
26						
27						
28						
29						

Operation

The operation executed by EX_POSING command is illustrated below.

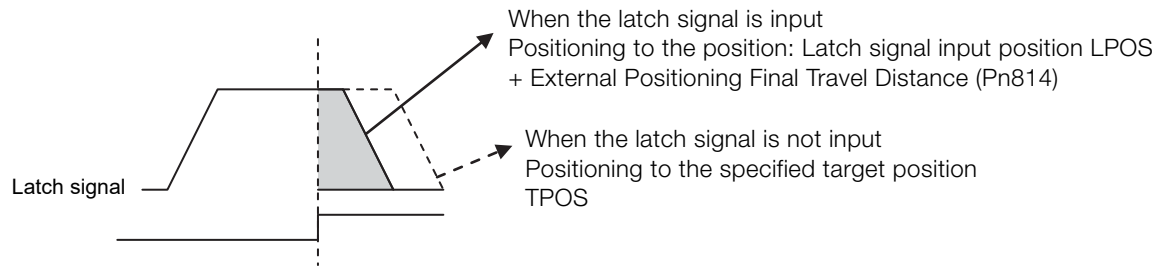

Related Parameters

The parameters related to this command are listed below.

Parameter No.	Name	Parameter No.	Name
Pn80A (Pn834*)	First Stage Linear Acceleration Constant (First Stage Linear Acceleration Constant 2)	Pn80F (Pn83E)	Deceleration Constant Switching Speed (Deceleration Constant Switching Speed 2)
Pn80B (Pn836*)	Second Stage Linear Acceleration Constant (Second Stage Linear Acceleration Constant 2)	Pn814	External Positioning Final Travel Distance
Pn80C (Pn838*)	Acceleration Constant Switching Speed (Acceleration Constant Switching Speed 2)	Pn820	Forward Latching Area
Pn80D (Pn83A*)	First Stage Linear Deceleration Constant (First Stage Linear Deceleration Constant 2)	Pn822	Reverse Latching Area
Pn80E (Pn83C*)	Second Stage Linear Deceleration Constant (Second Stage Linear Deceleration Constant 2)	Pn81F = n.□□X□	Position Control Command TFF/TLIM Allocation
-	-	Pn002 = n.□□□X	MECHATROLINK Command Position and Speed Control Option

* Parameters in parentheses are used when Pn833 is set to 1.

Set the parameters as shown below to use TLIM.

Parameter No.	Set Value	Meaning
Pn81F	n.□□1□	Enables positive/negative torque limit (TLIM).
Pn002	n.□□□1	
Pn81F	n.□□1□	When P_CL of OPTION field is set to 1: Uses TLIM as positive torque limit.
Pn002	n.□□□3	When N_CL of OPTION field is set to 1: Uses TLIM as negative torque limit.

3.2.9 ZRET (Origin Return) Command: 3A Hex

ZRET Command

The ZRET command is used to perform an origin return operation in the following sequence.

1. Accelerates to the target speed (TSPD) in the direction specified in Pn816 = n.□□□X (Origin Return Direction).
2. Decelerates to the origin approach speed 1 (Pn817 or Pn842) at the DEC = 1.
3. Latch operation will start at the DEC = 0.
4. When a latch signal is input, positioning is performed to define the target position at the origin approach speed 2 (Pn818 or Pn844). The target position is calculated by adding the final travel distance for origin approach (Pn819). After the completion of positioning, the coordinate system is set so that the position reached is 0.

Byte	ZRET		Description			
	Command	Response				
1	3A hex	3A hex	Phases in which the command can be executed	Phase 2 and 3	Synchronization classification	Asynchronous command
2	LT_SGNL	ALARM	Processing time	Within communications cycle	Subcommand	Can be used
3	OPTION	STATUS	<ul style="list-style-type: none"> • Use LT_SGNL to select the latch signal. Refer to the following section for details on LT_SGNL. ☞ 2.1.6 LT_SGNL Specifications on page 2-7 			
4						
5	-	MONITOR1	<p>When the latch signal is input, positioning is performed to define the target position at the origin approach speed 2 (Pn818). The target position is calculated by adding the final travel distance for origin return (Pn819).</p> <p>The position data is recorded as the feedback latch position (LPOS) of the machine coordinate system, and the LPOS will forcibly be indicated as the MONITOR2 for one communications cycle.</p> <p>When the latch signal is input, L_CMP of STATUS field is set to 1, and then reset to 0 at the completion of the origin return operation. Therefore, when the origin final travel distance is short, the duration L_CMP = 1 is too short so that the status L_CMP = 1 can not be confirmed.</p> <ul style="list-style-type: none"> • OPTION field can be used. 			
6						
7						
8						
9	TSPD	MONITOR2	<ul style="list-style-type: none"> • You can specify between the target speed (TSPD) and the maximum motor speed [reference units/s]. 			
10						
11						
12						
13	SEL_MON1/2	SEL_MON1/2	<ul style="list-style-type: none"> • The target speed during motion can be changed until DEC is input. • The torque limit (TLIM) can be used by setting Pn81F and Pn002. • TLIM setting range: 0 to 4000 hex [maximum motor torque/4000 hex] <p>If a value between 4000 hex and FFFF hex is set, the maximum motor torque will be applied as the limit.</p> <p>Use the ADJ command to obtain the maximum motor torque.</p> <ul style="list-style-type: none"> • Use DEN (output complete) and ZPOINT (home position) to confirm the completion of position reference output. • If any of the following commands is received during execution of ZRET command, the origin return operation will be interrupted. DISCONNECT, SYNC_SET, CONFIG, HOLD, SV_OFF, INTERPOLATE, POSING, FEED, LATCH, EX_POSING, VELCTRL, TRQCTRL, SVCTRL <p>When a command other than the above commands is received, the origin return operation will continue.</p> <ul style="list-style-type: none"> • A warning will occur and the command will be ignored in the following cases. <ul style="list-style-type: none"> • This command is used while the servo is OFF.: A.95A alarm (Command Warning 1) • The target speed (TSPD) exceeds the limit: A.94B alarm (Data Setting Warning 2) • When using SigmaWin or a digital operator for motor operations such as JOG: A.95A alarm (Command Warning 1) 			
14	TLIM	IO_MON				
15						
16	WDT	RWDT				
17	Subcommand area	Subcommand area				
18						
19						
20						
21						
22						
23						
24						
25						
26						
27						
28						
29						

Operation

The motion executed by ZRET command is illustrated below.

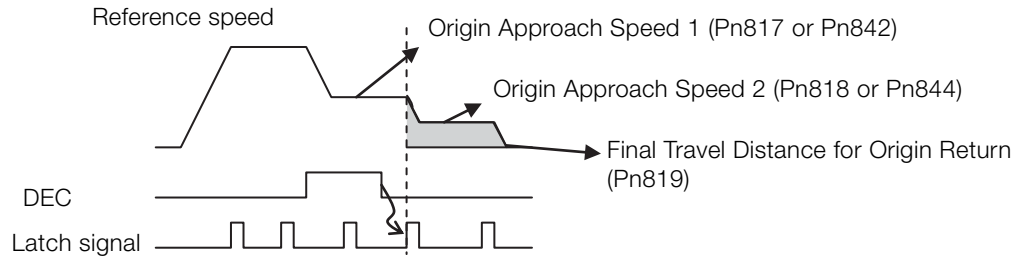

Related Parameters

The parameters related to this command are listed below.

Parameter No.	Name	Parameter No.	Name
Pn816 = n.□□□X	Origin Return Direction	Pn002 = n.□□□X	MECHATROLINK Command Position and Speed Control Option
Pn817	Origin Approach Speed 1 (Second Origin Approach Speed 1)* ¹	Pn80A (Pn834* ³)	First Stage Linear Acceleration Constant (First Stage Linear Acceleration Constant 2)
Pn842		Pn80B (Pn836* ³)	Second Stage Linear Acceleration Constant (Second Stage Linear Acceleration Constant 2)
Pn818	Origin Approach Speed 2 (Second Origin Approach Speed 2)* ²	Pn80C (Pn838* ³)	Acceleration Constant Switching Speed (Acceleration Constant Switching Speed 2)
Pn844		Pn80D (Pn83A* ³)	First Stage Linear Deceleration Constant (First Stage Linear Deceleration Constant 2)
Pn819	Final Travel Distance for Origin Return	Pn80E (Pn83C* ³)	Second Stage Linear Deceleration Constant (Second Stage Linear Deceleration Constant 2)
Pn820	Forward Latching Area	Pn80F (Pn83E* ³)	Deceleration Constant Switching Speed (Deceleration Constant Switching Speed 2)
Pn822	Reverse Latching Area	Pn81F = n.□□X□	Position Control Command TFF/TLIM Allocation

*1. The value of Pn842 is effective only when the value of Pn817 is 0.

*2. The value of Pn844 is effective only when the value of Pn818 is 0.

*3. Parameters in parentheses are used when Pn833 is set to 1.

Set the parameters as shown below to use TLIM.

Parameter No.	Set Value	Meaning
Pn81F	n.□□1□	Enables positive/negative torque limit (TLIM).
Pn002	n.□□□1	
Pn81F	n.□□1□	When P_CL of OPTION field is set to 1: Uses TLIM as positive torque limit. When N_CL of OPTION field is set to 1: Uses TLIM as negative torque limit.
Pn002	n.□□□3	

3.2.10 VELCTRL (Velocity Control) Command: 3C Hex

VELCTRL Command

The VELCTRL command is used to control speed. (The Servo does not perform position control, but directly controls the speed of the speed loop.)

Byte	VELCTRL		Description				
	Command	Response					
1	3C hex	3C hex	Phases in which the command can be executed	Phase 2 and 3	Synchronization classification	Asynchronous command	
2	–	ALARM	Processing time	Within communications cycle	Subcommand	Can be used	
3	OPTION	STATUS	<ul style="list-style-type: none"> OPTION field can be used. VREF is a speed reference and has a signed 4-byte data. The unit for speed reference is [maximum motor speed/40000000 hex]. The direction is specified by the sign. Soft-start function can be used. Refer to the following section for details on soft starts. <ul style="list-style-type: none">  <i>Soft Start Function</i> on page 3-47 Either torque limit (P_TLIM, N_TLIM) or torque feed forward (TFF) can be used. Use Pn002 to select. <ul style="list-style-type: none"> TLIM setting range: 0 to 4000 hex [maximum motor torque/4000 hex] <ul style="list-style-type: none"> (If a value between 4000 hex to FFFF hex is set, the maximum motor torque will be applied as the limit. Use the ADJ command to obtain the maximum motor torque. TFF setting range: A signed 2-byte data [maximum motor torque/4000 hex] During execution of this command, the following bits for STATUS are allocated. <ul style="list-style-type: none"> D8: ZSPD (zero speed bit) <ul style="list-style-type: none"> 0: Zero speed not detected 1: Zero speed detected D7: V_CMP (speed coincidence bit) <ul style="list-style-type: none"> 0: Speed coincidence not detected 1: Speed coincidence detected Monitor (MONITOR 1, 2, 3, 4) <ul style="list-style-type: none"> The units for TSPD, CSPD, and FSDP is [maximum motor speed / 40000000 hex]. 				
4							
5	P_TLIM /TFF	MONITOR1					
6							
7	N_TLIM						
8							
9	VREF	MONITOR2					
10							
11							
12							
13	SEL_MON1/2	SEL_MON1/2					
14	–	IO_MON					
15							
16	WDT	RWDT					
17	Subcom- mand area	Subcom- mand area					
18							
19							
20							
21							
22							
23							
24							
25							
26							
27							
28							
29							

Soft Start Function

The soft start function converts input speed references from sudden step progression to steady diagonal progression. Set the acceleration speed and deceleration speed in the following parameters.

Use this function to achieve a smooth speed control in speed control mode (excluding internal set speed selection).

Pn305	Soft Start Acceleration Time: Time of period the motor speed reaches the maximum from zero (the stop status)			
	Setting Range	Unit	Factory Setting	When Enabled
	0 to 10,000	1 ms	0	Immediately
Pn306	Soft Start Deceleration Time: Time of period the motor speed decreases to zero (stop status) from the maximum.			
	Setting Range	Unit	Factory Setting	When Enabled
	0 to 10,000	1 ms	0	Immediately

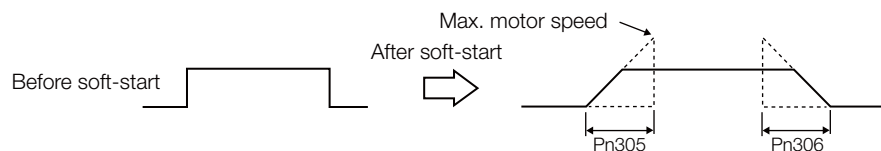

Note: For normal speed control, set Pn305 and Pn306 to 0 (factory setting).

Torque Reference Option

The settings of the parameters related to the torque reference option for VELCTRL command are listed below.

Parameter	Description
n.□□□0	The set values of P_TLIM and N_TLIM are invalid. (factory setting)
n.□□□1	Uses the set value of P_TLIM/N_TLIM as forward/reverse torque limit.
n.□□□2	Uses TFF as the torque feed forward. Set N_TLIM to 0.
n.□□□3	When P_CL of OPTION field is set to 1, uses P_TLIM as the torque limit. When N_CL of OPTION field is set to 1, uses N_TLIM as the torque limit.

3.2.11 TRQCTRL (Torque Control) Command: 3D Hex

TRQCTRL

The TRQCTRL command is used to control torque. (The Servo does not perform position control and speed control, but directly performs torque control.)

Byte	TRQCTRL		Description			
	Command	Response				
1	3D hex	3D hex	Phases in which the command can be executed	Phase 2 and 3	Synchronization classification	Asynchronous command
2	–	ALARM	Processing time	Within communications cycle	Subcommand	Can be used
3	OPTION	STATUS	<ul style="list-style-type: none"> OPTION field can be used. VLIM is a speed limit value and has an unsigned 4-byte data. The unit for the speed limit is [maximum motor speed /40000000 hex]. (Set Pn002 to enable VLIM.) Use the ADJ command to obtain the maximum motor speed. TQREF is a torque reference and has a signed 4-byte data. The unit for torque reference is [maximum motor torque/40000000 hex]. The direction is specified by the sign. When the designation for TQREF exceeds the maximum motor torque, it is clamped at the maximum motor torque. Use ADJ command to obtain the maximum motor torque. During execution of this command, the following bits of STATUS field are allocated. <ul style="list-style-type: none"> D11: V_LIM (speed limit bit) <ul style="list-style-type: none"> 0: Speed limit not detected 1: Speed limit detected Monitor (MONITOR 1, 2, 3, 4) <ul style="list-style-type: none"> The unit for TRQ is maximum motor torque/40000000 hex. 			
4						
5	VLIM	MONITOR1				
6						
7						
8						
9	TQREF	MONITOR2				
10						
11						
12						
13	SEL_MON1/2	SEL_MON1/2				
14	–	IO_MON				
15						
16	WDT	RWDT				
17	Subcommand area	Subcommand area				
18						
19						
20						
21						
22						
23						
24						
25						
26						
27						
28						
29						

Speed Limit Option 1

◆ When Using a Rotational Servomotor

Use Pn407 (Speed Limit during Torque Control) to set the speed limit.

Pn407	Speed Limit during Torque Control			
	Setting Range	Unit	Factory Setting	When Enabled
	0 to 10,000	1 min ⁻¹	10000	Immediately

Note: If a speed higher than the maximum speed of the connected servomotor is set, the servomotor speed will be limited to its maximum speed.

◆ When Using a Linear Servomotor

Use Pn480 (Speed Limit during Force Control) to set the speed limit.

Pn480	Speed Limit during Force Control			
	Setting Range	Unit	Factory Setting	When Enabled
	0 to 5,000	1 mm/s	5000	Immediately

Note: If a speed higher than the maximum speed of the connected linear servomotor is set, the linear servomotor speed will be limited to its maximum speed.

Speed Limit Option 2

Set the following parameter to enable VLIM (Speed Limit) specified in TRQCTRL command.

Parameter	Description
Pn002	n.□□0□
	Disables VLIM. (factory setting)
	n.□□1□
	Enables VLIM (Uses VLIM as the speed limit.)

3.2.12 Restrictions in Using Servo Commands

Travel Distance Restrictions for the ZRET (Zero Point Return) Command

If you use the ZRET (Zero Point Return) command for a Σ -7-Series Rotary Servomotor, the following restrictions apply according to the setting of the electronic gear ratio.

Electric Gear Ratio (Pn20E/Pn210)	Travel Distance
1/1	Distance equivalent to ± 64 rotations
2/1	Distance equivalent to ± 128 rotations
4/1	Distance equivalent to ± 256 rotations
16/1	Distance equivalent to $\pm 1,024$ rotations

Travel Distance Restrictions for the EX_POSING (External Input Positioning) and EX_FEED (External Input Feed) Commands

If you use the EX_POSING (External Input Positioning) or EX_FEED (External Input Feed) command for a Σ -7-Series Rotary Servomotor, the following restrictions apply according to the setting of the electronic gear ratio.

Electric Gear Ratio (Pn20E/Pn210)	Travel Distance
1/1	Distance equivalent to ± 64 rotations
2/1	Distance equivalent to ± 128 rotations
4/1	Distance equivalent to ± 256 rotations
16/1	Distance equivalent to $\pm 1,024$ rotations

Travel Distance Restrictions for the TPOS (Target Position)

If you use TPOS (Target Position) for a Σ -7-Series Rotary Servomotor, the following restrictions apply according to the setting of the electronic gear ratio.

Electric Gear Ratio (Pn20E/Pn210)	Travel Distance
1/1	Distance equivalent to ± 128 rotations
2/1	Distance equivalent to ± 256 rotations
4/1	Distance equivalent to ± 512 rotations
16/1	Distance equivalent to $\pm 2,048$ rotations

Deceleration Time Restrictions during Position Control

If you use a positioning command (i.e., POSING, FEED, EX_FEED, EX_POSING, or ZRET) for a Σ -7-Series Rotary Servomotor, the following restrictions apply to the deceleration time.

Electric Gear Ratio (Pn20E/Pn210)	Deceleration Time at 750 min ⁻¹ [s]	Deceleration Time at 1,500 min ⁻¹ [s]	Deceleration Time at 3,000 min ⁻¹ [s]	Deceleration Time at 6,000 min ⁻¹ [s]
1/1	20.48	10.24	5.12	2.56
2/1	40.96	20.48	10.24	5.12
4/1	81.92	40.96	20.48	10.24
16/1	327.68	163.84	81.92	40.96

The following figure shows the relationship between the reference speed and deceleration time.

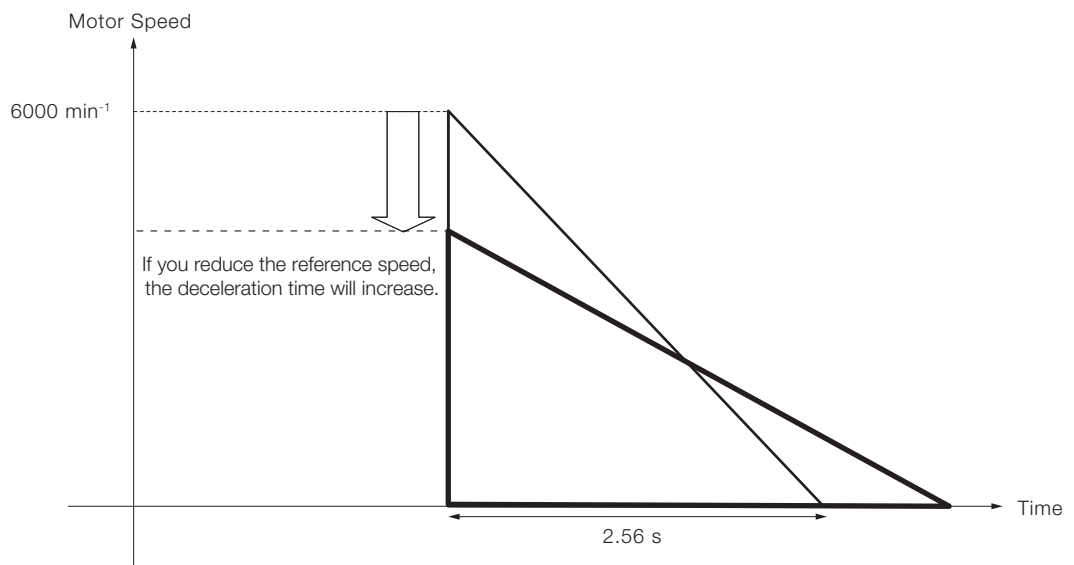

Subcommands

4

This chapter describes MECHATROLINK-II subcommands.

4.1 MECHATROLINK-II Subcommands List . . . 4-2

4.2 MECHATROLINK-II Subcommands Details . 4-3

- 4.2.1 NOP (No Operation) Command: 00 Hex 4-3
- 4.2.2 PRM_RD (Read Parameter) Command: 01 Hex . . 4-3
- 4.2.3 PRM_WR (Write Parameter) Command: 02 Hex . 4-4
- 4.2.4 ALM_RD (Read Alarm or Warning) Command:
05 Hex 4-4
- 4.2.5 PPRM_WR (Write Non-volatile Parameter)
Command: 1C Hex 4-5
- 4.2.6 LTMOD_ON (Set Latch Mode) Command:
28 Hex 4-5
- 4.2.7 LTMOD_OFF (Release Latch Mode) Command:
29 Hex 4-6
- 4.2.8 SMON (Status Monitoring) Command: 30 Hex . . 4-6

4.1 MECHATROLINK-II Subcommands List

The MECHATROLINK-II subcommands can be used by specifying them with the CONNECT command when MECHATROLINK-II communications starts.

The specifications of each MECHATROLINK-II subcommand are described below.

Refer to the following section for information on applicable combinations with main commands.

 1.4.3 *Combination of MECHATROLINK-II Main Commands and Subcommands* on page 1-8

Command Code	Command	Function
00 hex	NOP	Same function as of the main command NOP
01 hex	PRM_RD	Same function as of the main command PRM_RD
02 hex	PRM_WR	Same function as of the main command PRM_WR
05 hex	ALM_RD	Same function as of the main command ALM_RD
1C hex	PPRM_WR	Same function as of the main command PPRM_WR
28 hex	LTMOD_ON	Same function as of the main command LTMOD_ON
29 hex	LTMOD_OFF	Same function as of the main command LTMOD_OFF
30 hex	SMON	Same function as of the main command SMON

4.2 MECHATROLINK-II Subcommands Details

4.2.1 NOP (No Operation) Command: 00 Hex

Byte	NOP		Description	
	Command	Response		
17	00 hex	00 hex	<ul style="list-style-type: none"> Not operation command 	
18	-	SUBSTATUS		
19		-		
20				
21				
22				
23				
24				
25				
26				
27				
28				
29				

4.2.2 PRM_RD (Read Parameter) Command: 01 Hex

Byte	PRM_RD		Description
	Command	Response	
17	01 hex	01 hex	<ul style="list-style-type: none"> Reads the parameters. This command has the same function as the main command PRM_RD.
18	-	SUBSTATUS	
19	NO	NO	
20			
21			
22	-	PARAMETER	
23			
24			
25			
26			
27			
28			
29			

4.2.3 PRM_WR (Write Parameter) Command: 02 Hex

Byte	PRM_WR		Description
	Command	Response	
17	02 hex	02 hex	<ul style="list-style-type: none"> Writes the parameters. This command has the same function as the main command PRM_WR.
18	–	SUBSTATUS	
19	NO	NO	
20			
21	SIZE	SIZE	
22	PARAMETER	PARAMETER	
23			
24			
25			
26			
27			
28			
29			

4.2.4 ALM_RD (Read Alarm or Warning) Command: 05 Hex

Byte	ALM_RD		Description
	Command	Response	
17	05 hex	05 hex	<ul style="list-style-type: none"> Reads the alarm or warning. This command has the same function as the main command ALM_RD. When ALM_RD_MOD is set to 2 or 3, an alarm index will be assigned to byte 20 in the command and the response. An alarm code is assigned to both byte 21 and byte 22 in the response.
18	–	SUBSTATUS	
19	ALM_RD_MOD	ALM_RD_MOD	
20	–	ALM_DATA	
21			
22			
23			
24			
25			
26			
27			
28			
29			

4.2.5 PPRM_WR (Write Non-volatile Parameter) Command: 1C Hex

Byte	PPRM_WR		Description
	Command	Response	
17	1C hex	1C hex	<ul style="list-style-type: none"> Writes the parameters. This command has the same function as the main command PPRM_WR.
18	–	SUBSTATUS	
19	NO	NO	
20			
21	SIZE	SIZE	
22	PARAMETER	PARAMETER	
23			
24			
25			
26			
27			
28			
29			

4.2.6 LTMOD_ON (Set Latch Mode) Command: 28 Hex

Byte	PPRM_WR		Description
	Command	Response	
17	28 hex	28 hex	<ul style="list-style-type: none"> Enables the latch mode. This command has the same function as the main command LTMOD_ON.
18	LT_SGN	SUBSTATUS	
19	SEL_MON3/4	SEL_MON3/4	
20	LT_MOD	MONITOR3	
21	–		
22			
23			
24		MONITOR4	
25			
26		EX_STATUS	
27			
28			
29	–		

4.2.7 LTMOD_OFF (Release Latch Mode) Command: 29 Hex

Byte	LTMOD_OFF		Description
	Command	Response	
17	29 hex	29 hex	<ul style="list-style-type: none"> Releases the latch mode. This command has the same function as the main command LTMOD_OFF.
18	-	SUBSTATUS	
19	SEL_MON3/4	SEL_MON3/4	
20	-	MONITOR3	
21			
22			
23			
24		MONITOR4	
25			
26			
27	EX_STATUS		
28			
29			

4.2.8 SMON (Status Monitoring) Command: 30 Hex

Byte	SMON		Description
	Command	Response	
17	30 hex	30 hex	<ul style="list-style-type: none"> Reads the monitoring information specified in SEL_MON3/4. This command has the same function as the main command SMON.
18	-	SUBSTATUS	
19	SEL_MON3/4	SEL_MON3/4	
20	-	MONITOR3	
21			
22			
23			
24		MONITOR4	
25			
26			
27	EX_STATUS		
28			
29			

Operation Sequence

5

This chapter describes basic operation sequences through MECHATROLINK-II communications.

5.1	Preparing for Operation	5-2
5.1.1	Setting MECHATROLINK-II Communications . . .	5-2
5.1.2	Checking the Communications Status	5-4
5.2	Operation Sequence for Managing Parameters Using a Controller	5-5
5.3	Operation Sequence for Managing Parameters Using a SERVOPACK . . .	5-6
5.3.1	Setup Sequence	5-6
5.3.2	Ordinary Operation Sequence	5-6
5.4	Specific Operation Sequences	5-7
5.4.1	Operation Sequence When Turning the Servo ON	5-7
5.4.2	Operation Sequence When OT (Overtravel Limit Switch) Signal Is Input	5-7
5.4.3	Operation Sequence at Emergency Stop (Main Circuit OFF)	5-8
5.4.4	Operation Sequence When a Safety Signal is Input . . .	5-8
5.4.5	Operation Sequence at Occurrence of Alarm . . .	5-9
5.4.6	When Motion Command Is Interrupted and Servomotor Is in Position	5-9
5.5	Setting the Origin Before Starting Operation . .	5-10
5.5.1	When Using an Incremental Encoder	5-10
5.5.2	When Using an Absolute Encoder	5-10

5.1 Preparing for Operation

This section describes how to set communications specifications before starting communications, and how to confirm the communications status.

5.1.1 Setting MECHATROLINK-II Communications

The rotary switch (S2) and DIP switch (S3) that are located near the top under the front cover of the SERVOPACK are used to set communications specifications.

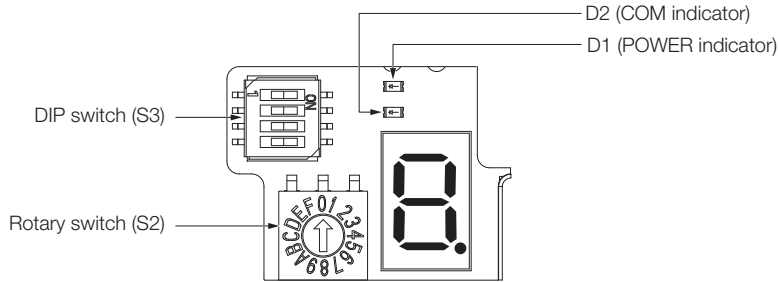

Setting the Communications Specifications

Use the DIP switch (S3) to make the communications settings.

DIP Switch (S3)	Function	Setting	Description	Factory Setting
Pin 1	Sets the baud rate.	OFF	4 Mbps (MECHATROLINK-I)	ON
		ON	10 Mbps (MECHATROLINK-II)	
Pin 2	Sets the number of transmission bytes.	OFF	17 bytes	ON
		ON	32 bytes	
Pin 3	Sets the station address.	OFF	Station address = 40 hex + Setting of S2	OFF
		ON	Station address = 50 hex + Setting of S2	
Pin 4	Reserved. (Do not change.)	OFF	-	OFF



Important

- When connecting to a MECHATROLINK-I network, turn OFF pins 1 and 2.
- When using a MECHATROLINK-I network (Baud rate: 4 Mbps), the settings for the number of transmission bytes is disabled and the number of transmission bytes is always 17.

Setting the Station Address

Use the following settings table to set the station address. The station address is set on the rotary switch (S2) and the DIP switch (S3).

The default setting of the station address is 41 hex (pin 3 on S3 = OFF, S2 = 1).

Pin 3 on S3	S2	Station Address	Pin 3 on S3	S2	Station Address
OFF	0	Disabled	ON	0	50 hex
OFF	1	41 hex	ON	1	51 hex
OFF	2	42 hex	ON	2	52 hex
OFF	3	43 hex	ON	3	53 hex
OFF	4	44 hex	ON	4	54 hex
OFF	5	45 hex	ON	5	55 hex
OFF	6	46 hex	ON	6	56 hex
OFF	7	47 hex	ON	7	57 hex
OFF	8	48 hex	ON	8	58 hex
OFF	9	49 hex	ON	9	59 hex
OFF	A	4A hex	ON	A	5A hex
OFF	B	4B hex	ON	B	5B hex
OFF	C	4C hex	ON	C	5C hex
OFF	D	4D hex	ON	D	5D hex
OFF	E	4E hex	ON	E	5E hex
OFF	F	4F hex	ON	F	5F hex



Important

Turn the power OFF and then ON again to validate the new settings.

5.1.2 Checking the Communications Status

Turn ON the control and main circuit power supplies and use the following procedure to confirm that the SERVOPACK is ready for communications.

Operation Procedure

Proce- dure	Operation
1	Confirm that the wiring is correctly made.
2	Turn ON the SERVOPACK control and main circuit power supplies. If the control power is supplied normally to the SERVOPACK, the D1 (POWER) indicator on the SERVOPACK will light. When the main circuit power supply is ON, CHARGE is lit.
3	Turn ON the controller power supply and start MECHATROLINK communications.
4	<p>Check the communications status. When communications in the data link layer have started, the D2 (COM) indicator on the SERVOPACK will light. Note: If the D2 (COM) indicator does not light, check the communications settings on S2 and S3, check the controller's communications settings, and then turn the power supply OFF and ON again. When the MECHATROLINK-II connection in the application layer is established, the 7-segment LED indicates the completion of CONNECT execution as shown below.</p> <div style="margin-left: 20px;"> <p><input type="checkbox"/> ← D1 (POWER indicator)</p> <p><input type="checkbox"/> ← D2 (COM indicator)</p> </div> <div style="margin-left: 20px;">  <p>When lit: CONNECT execution completed When unlit: CONNECT execution not completed</p> </div>

5.2

Operation Sequence for Managing Parameters Using a Controller

When the parameters are managed by a controller, the parameters are automatically transmitted from the controller to the SERVOPACK when the power is turned ON. Therefore, the settings of SERVOPACK do not need to be changed when the SERVOPACK is replaced.

Procedure	Operation	Command to Send
1	Turn on the control and main circuit power supplies.	NOP
2	Reset the previous communications status.	DISCONNECT*
3	Establish communications connection and starts WDT count.	CONNECT
4	Check information such as device ID.	ID_RD
5	Get device setting data such as parameters.	PRM_RD, ADJ
6	Set the parameters required for device.	PRM_WR
7	Enable the parameter settings (Setup).	CONFIG
8	Turn the encoder power supply to the position data.	SENS_ON
9	Turn the servo on.	SV_ON
10	Start operation.	–
11	Turn the servo off.	SV_OFF
12	Disconnect the communications connection.	DISCONNECT
13	Turn the control and main circuit power supplies.	–

* If the connection cannot be released normally, send DISCONNECT command for 2 or more communications cycles, and then send CONNECT command.

5.3 Operation Sequence for Managing Parameters Using a SERVOPACK

To manage the parameters by using SERVOPACK's non-volatile memory, save the parameters in the non-volatile memory at setup and use an ordinary operation sequence.

5.3.1 Setup Sequence

Procedure	Operation	Command to Send
1	Turn on the control and main circuit power supply.	NOP
2	Reset the previous communications status.	DISCONNECT*
3	Establish communications connection and start WDT count.	CONNECT
4	Check information such as device ID.	ID_RD
5	Get device setting data such as parameters.	PRM_RD, ADJ
6	Save the parameters required for device in the non-volatile memory.	PPRM_WR Note: Do not use PRM_WR.
7	Disconnect the communications connection.	DISCONNECT
8	Turn off the control and main circuit power supplies.	—

* If the connection cannot be released normally, send a DISCONNECT command for 2 or more communications cycles, and then send a CONNECT command.

5.3.2 Ordinary Operation Sequence

Procedure	Operation	Command to Send
1	Turn on the control and main circuit power supplies.	NOP
2	Reset the previous communications status.	DISCONNECT*
3	Establish communications connection and start WDT count.	CONNECT
4	Check information such as device ID.	ID_RD
5	Get device setting data such as parameters.	PRM_RD, ADJ
6	Turn on the encoder power supply to get the position data.	SENS_ON
7	Turn the servo on.	SV_ON
8	Start operation.	POSING, INTERPOLATE, etc.
9	Turn the servo off.	SV_OFF
10	Disconnect the communications connection.	DISCONNECT
11	Turn off the control and main circuit power supplies.	—

* If the connection cannot be released normally, send a DISCONNECT command for 2 or more communications cycles, and then send a CONNECT command.

5.4 Specific Operation Sequences

This section describes operations that use commands in specific sequences.

5.4.1 Operation Sequence When Turning the Servo ON

Motor control using a host controller is performed using motion commands only during Servo ON (motor power ON).

While the SERVOPACK is in Servo OFF status (while current to the motor is interrupted), the SERVOPACK manages position data so that the reference coordinate system (POS, MPOS) and the feedback coordinate system (APOS) are equal. For correct execution of motion commands, therefore, it is necessary to use the SMON (Status Monitoring) command after the SERVOPACK status changes to Servo ON, to read the servo reference coordinates (POS) and send an appropriate reference position.

Confirm the following bit status before sending the SV_ON command:

STATUS field: PON = 1 and ALM = 0

IO Monitor field: HBB = 0

5.4.2 Operation Sequence When OT (Overtravel Limit Switch) Signal Is Input

When the OT signal is input, the SERVOPACK will prohibit the motor from operation with the method specified in Pn001. The SERVOPACK continues to control the motor while motor operation is prohibited.

When an OT signal is input, use the following procedure to process the OT signal.

Procedure	Operation
1	Monitor OT signals (P_OT and N_OT of IO Monitor field). When an OT signal is input, send an appropriate stop command: While an interpolation command (INTERPOLATE, LATCH) is being executed: Leave the interpolation command as it is and stop updating the interpolation position. Or, send a HOLD command and SMON command. While a move command (such as POSING) other than interpolation commands is being executed: Send a HOLD command.
2	Check the output completion flag DEN. If DEN = 1, the SERVOPACK completed the OT processing. At the same time, check the flag PSET. If PSET = 1, the motor is completely stopped. Keep the command used in procedure 1 active until both of the above flags are set to 1.
3	Read out the current reference position (POS) and use it as the start position for retraction processing.
4	Use a move command such as POSING or INTERPOLATE for retraction processing. Continue to use this command until the retraction is finished. If the move command ends without finishing the retraction, restart the move command continuously from the last target position.

Note: 1. When an OT signal is input during execution of motion command ZRET or EX_POSING, the execution of the command will be cancelled. For retraction, always send a stop command described in procedure 1 first, and then send a retraction command (move command).

2. In case of OT ON (P-OT or N-OT of IO_MON field = 1) or Software-Limit ON (P_SOT or N_SOT of STATUS field = 1), the motor may not reach the target position that the host controller specified. Make sure that the axis has stopped at a safe position by confirming the feedback position (APOS).



The host controller may not be able to monitor a brief change in the P-OT or N-OT signal to P-OT=1 or N-OT=1. Proper selection, installation and wiring in the limit switch is required to avoid chattering and malfunctions in the OT signal.

5.4.3 Operation Sequence at Emergency Stop (Main Circuit OFF)

After confirming that SV_ON or PON bit in the response data STATUS field is OFF (= 0), send an SV_OFF command.
 During emergency stop, always monitor the SERVOPACK status using a command such as the SMON (Status Monitoring) command.

5.4.4 Operation Sequence When a Safety Signal is Input

When the HWBB1 or HWBB2 signal is input while the motor is operating, power to the motor will be forcibly shut OFF and the motor will be stopped according to the setting of Pn001 = n.□□□X.

■ When an HWBB signal is input after the SERVOPACK stops powering the motor

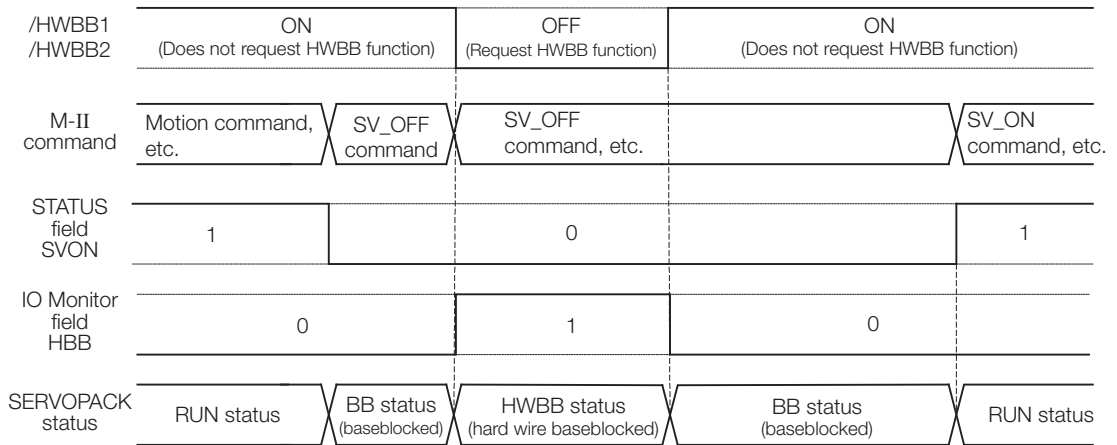

■ When an HWBB signal is input while the SERVOPACK is powering the motor

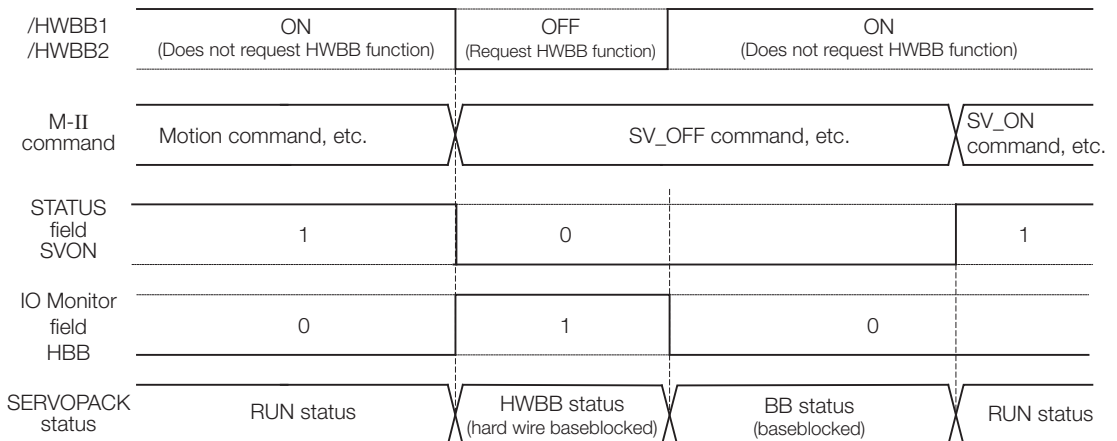

◆ When an HWBB Signal is Input

Monitor the HWBB input signal and SCM output signal status, or HBB signal status in IO Monitor field. If a forced stop status is detected, send a command such as SV_OFF to stop the motor.

◆ Restoration from Stop Status

Reset the HWBB1 or HWBB2 signal, and then send a command other than SV_ON, such as SV_OFF. Then, restore the controller and system. When the controller and system are restored, turn the servo ON using the operation sequence to turn the servo ON.

Note: 1. If the SERVOPACK enters HWBB status while sending an SV_ON command, reset the /HWBB1 or /HWBB2 signal and then send a command other than SV_ON, such as SV_OFF. Then, send the SV_ON command again to restore the normal operation status.

2. If the SERVOPACK enters HWBB status during execution of an SV_OFF, INTERPOLATE, LATCH, POSING, FEED, EX_POSING, or ZRET command, a command warning will occur since the SERVOPACK status changes to Servo OFF status. Execute the Clear Alarm or Warning (ALM_CLR) command to restore normal operation.

5.4.5 Operation Sequence at Occurrence of Alarm

When the ALM bit in STATUS field of response turns on (= 1), send SV_OFF command. Use ALM_RD command to check the alarm occurrence status.

To clear the alarm status, send ALM_CLR command after removing the cause of alarm. However, the alarms that require turning the power supply off and then on again to clear the alarm status, sending ALM_CLR command will not clear the alarm status.

If a communications alarm A.E5□ or A.E6□ occurs, send ALM_CLR command to reset the alarm and then send SYNC_SET command.

5.4.6 When Motion Command Is Interrupted and Servomotor Is in Position

During execution of a Motion command, any one of the following statuses on the SERVOPACK will cause interruption of the motion command and an in-position status of PSET = 1.

- Alarm occurrence (ALM of STATUS field = 1) causes Servo-Off (SVON of STATUS field = 0).
- Main power supply OFF (PON of STATUS field = 0) causes Servo-Off (SVON of STATUS field = 0).
- OT ON (P-OT or N-OT of IO_MON field = 1) or Software-Limit ON (P_SOT or N_SOT of STATUS field = 1) causes the motor to stop.

Even when PSET is 1 in these cases, the motor may not reach the target position that the host controller specified. Obtain the feedback position (APOS) to make sure that the axis has stopped at a safe position.



Important

The host controller may not be able to monitor a brief change in the P-OT or N-OT signal to P-OT=1 or N-OT=1. Proper selection, installation and wiring in the limit switch is required to avoid chattering and malfunctions in the OT signal.

5.5 Setting the Origin Before Starting Operation

5.5.1 When Using an Incremental Encoder

When an incremental encoder is used in the slave station, carry out an origin return operation after turning ON the power supply.
 After the origin is set, set the reference coordinate system to determine the work coordinate origin as required:

■ **Setting the Reference Coordinate System Using ZRET Command**

The master station (controller) uses ZRET command to return the slave station to the origin and sets the reference coordinate system based on the origin.

■ **Setting the Reference Coordinate System Using POS_SET Command**

The master station (controller) uses POS_SET command to set the reference coordinate system of the slave station.

1. Position to the reference position.
2. Send the POS_SET command with POS_SET_MODE.POS_SEL = APOS (= 3), POS_SET_MODE.REFE = 1, and POS_DATA = reference position.

ZPOINT and software limits are enabled after the reference coordinate system has been set.

5.5.2 When Using an Absolute Encoder

When an absolute encoder is used in the slave station, SENS_ON command can be used to set the reference coordinate system of the slave station. The reference coordinate system will be set according to the position detected by the absolute encoder and the coordinate system offset of the encoder (i.e., the offset between the encoder’s coordinate system and the reference coordinate system (device built-in parameter)).

The relationship between the reference coordinate system (POS and APOS), the encoder’s coordinate system, and the coordinate system offset of the encoder are shown in the following figure.

POS: Reference position
 APOS: Feedback position

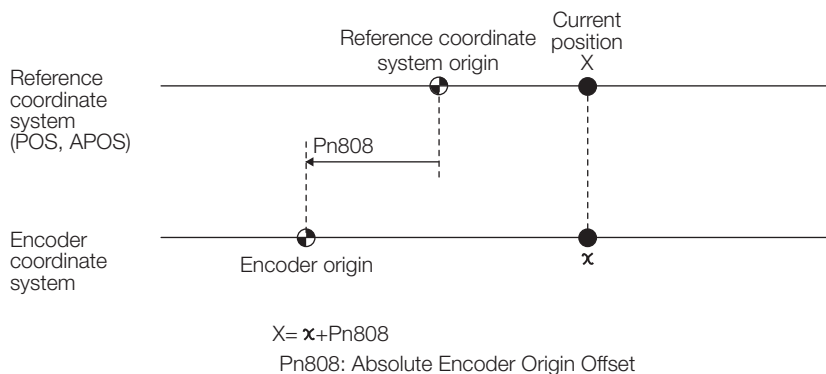

Command Related Parameters

6

This chapter describes parameter settings related to each command action.

6.1 Command Related Parameters List 6-2

6.2 Command Related Parameters Details 6-4

6.2.1	Electronic Gear Settings	6-4
6.2.2	Motion Acceleration/Deceleration Function Setting	6-10
6.2.3	Motion Sequence Setting	6-14
6.2.4	Command Data Options	6-15
6.2.5	Position Data Latch Function Setting	6-21
6.2.6	Settings for Acceleration/Deceleration Parameter High-speed Switching	6-24
6.2.7	STATUS Field and Monitor Related Settings . . .	6-27

6.1 Command Related Parameters List

This chapter describes the following parameters related to command actions.

Classification	Parameter	Name	Description
Settings According to Machine	Pn20E, Pn210	Electronic Gear Ratio (Numerator), Electronic Gear Ratio (Denominator)	Sets the unit of position data.
	Pn000 = n.□□□X	Rotation Direction Selection	Sets the servomotor rotation direction.
	Pn50A = n.X□□□, Pn50B = n.□□□X	P-OT (Forward Drive Prohibit) Signal Allocation, N-OT (Reverse Drive Prohibit) Signal Allocation	Sets the overtravel function and software limit operation.
	Pn801 = n.□□□X	Software Limit Selection	
	Pn804, Pn806	Forward Software Limit, Reverse Software Limit	
	Pn808	Absolute Encoder Origin Offset	Sets the origin when using an absolute encoder.
Motion Acceleration/Deceleration Function Settings	Pn833	Motion Settings	Sets the acceleration/deceleration speed for POSING, EX_POSING, FEED, ZRET, HOLD commands
	Pn80A, Pn834	First Stage Linear Acceleration Constant, First Stage Linear Acceleration Constant 2	
	Pn80B, Pn836	Second Stage Linear Acceleration Constant, Second Stage Linear Acceleration Constant 2	
	Pn80C, Pn838	Acceleration Constant Switching Speed, Acceleration Constant Switching Speed 2	
	Pn80D, Pn83A	First Stage Linear Deceleration Constant, First Stage Linear Deceleration Constant 2	
	Pn80E, Pn83C	Second Stage Linear Deceleration Constant, Second Stage Linear Deceleration Constant 2	
	Pn80F, Pn83E	Deceleration Constant Switching Speed, Deceleration Constant Switching Speed 2	
	Pn827, Pn840	Linear Deceleration Constant 1 for Stopping, Linear Deceleration Constant 2 for Stopping	Sets the deceleration speed for HOLD, SV_OFF commands.
	Pn829	SVOFF Waiting Time (for SVOFF at Deceleration to Stop)	
	Pn810	Exponential Acceleration/Deceleration Bias	Sets the position reference filter.
	Pn811	Exponential Acceleration/Deceleration Time Constant	
Pn812	Movement Average Time		
Motion Sequence Setting	Pn814	External Positioning Final Travel Distance	Sets the travel distance after the external signal is input for positioning.
	Pn816	Origin Return Mode Settings	Sets the origin return operation.
	Pn817, Pn818, Pn842, Pn844	Origin Approach Speed 1, Origin Approach Speed 2, Second Origin Approach Speed 1, Second Origin Approach Speed 2	
	Pn819	Final Travel Distance for Origin Return	

Continued on next page.

Continued from previous page.

Classification	Parameter	Name	Description
Command Data Option Setting	Pn81F = n.□□X□, Pn002 = n.□□□X	Position Control Command TFF/TLIM Allocation, MECHATROLINK Command Position and Speed Control Option	Sets the usage of torque limit and torque feed forward during position/speed control.
	Pn002 = n.□□X□, Pn407, Pn480	Torque Control Option, Speed Limit during Torque Control, Speed Limit during Force Control	Sets the usage of speed limit during torque control.
	Pn81F = n.□□□X, Pn82A to Pn82E	Option Field Allocation	Selects function bits to be assigned in OPTION field.
Position Data Latch Function Setting	Pn820, Pn822	Forward Latching Area, Reverse Latching Area	Sets the range to latch position data.
	Pn850	Number of Latch Sequences	Sets continuous latch operation executed by LTMOD_ON command.
	Pn851	Continuous Latch Sequence Count	
	Pn852, Pn853	Latch Sequence 1 to 4 Settings, Latch Sequence 5 to 8 Settings	
Acceleration/Deceleration Parameter High-speed Switching Function Setting	Pn900	Number of Parameter Banks	Sets the acceleration/deceleration parameter high-speed switching function.
	Pn901	Number of Parameter Bank Members	
	Pn902 to Pn910	Parameter Bank Member Definition	
	Pn920 to Pn95F	Parameter Bank Data	
STATUS Field and Monitor Related Settings	Pn803	Origin Range	Sets the following monitoring items. <ul style="list-style-type: none"> • STATUS field signal status detection level • Input signal allocation to the D12 to D15 bits of I/O Monitor field • Data mapping to option monitors
	Pn522	Positioning Completed Width	
	Pn524	Near Signal Width	
	Pn502, Pn581	Rotation Detection Level, Zero Speed Level	
	Pn503, Pn582	Speed Coincidence Detection Signal Output Width	
	Pn81E	Input Signal Monitor Selections	
	Pn824, Pn825	Option Monitor 1 Selection, Option Monitor 2 Selection,	

6.2 Command Related Parameters Details

6.2.1 Electronic Gear Settings

The minimum unit of the position data that is used to move a load is called the reference unit. The reference unit is used to give travel amounts, not in pulses, but rather in distances or other physical units (such as μm or $^\circ$) that are easier to understand.

The electronic gear is used to convert the travel distances that are specified in reference units to pulses, which are required for actual movements.

With the electronic gear, one reference unit is equal to the workpiece travel distance per reference pulse input to the SERVOPACK. In other words, if you use the SERVOPACK's electronic gear, pulses can be read as reference units.

Note: If you set an electronic gear in the host controller, normally set the electronic gear ratio in the SERVOPACK to 1:1.

The difference between using and not using the electronic gear is shown below.

• Rotary Servomotors

In this example, the following machine configuration is used to move the workpiece 10 mm.

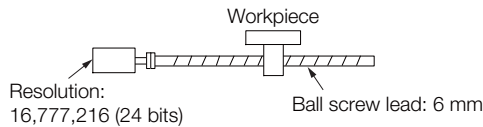

When the Electronic Gear Is Not Used

To move a workpiece 10 mm:
 ① Calculate the number of revolutions.
 The motor will move 6 mm for each revolution, so $10/6$ revolutions are required to move 10 mm.
 ② Calculate the required number of reference pulses.
 One revolution is 16,777,216 pulses, therefore $10/6 \times 16,777,216 = 27,962,026.66$ pulses.
 ③ Input 27,962,027 pulses as the reference.

Calculating the number of reference pulses for each reference is troublesome.

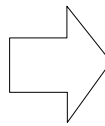

When the Electronic Gear Is Used

If you use reference units to move the workpiece when one reference unit is set to $1 \mu\text{m}$, the travel distance is $1 \mu\text{m}$ per pulse.
 To move the workpiece 10 mm ($10,000 \mu\text{m}$), $10,000 \div 1 = 10,000$ pulses, so 10,000 pulses would be input.

Calculating the number of reference pulses for each reference is not necessary.

• Linear Servomotors

In this example, the following machine configuration is used to move the load 10 mm. We'll assume that the resolution of the Serial Converter Unit is 256 and that the linear encoder pitch is $20 \mu\text{m}$.

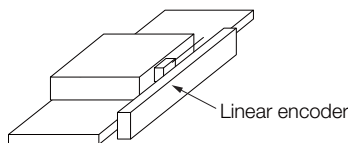

When the Electronic Gear Is Not Used

To move the load 10 mm:
 $10 \times 1000 \div 20 \times 256 = 128,000$
 pulses, so 128,000 pulses are input
 as the reference.

Calculating the number of reference
 pulses for each reference is trouble-
 some.

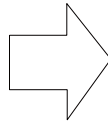

When the Electronic Gear Is Used

To use reference units to move the load 10 mm:
 If we set the reference unit to 1 μm, the travel
 distance is 1 μm per pulse. To move the load 10
 mm (10,000 μm), $10,000/1 = 10,000$ pulses, so
 10,000 pulses would be input as the reference.

Calculating the number of reference pulses
 for each reference is not necessary.

Electronic Gear Ratio Settings

Set the electronic gear ratio using Pn20E and Pn210.



Important

The setting range of the electronic gear depends on the setting of Pn040 = n.□□X□ (Encoder Resolution Compatibility Selection).

- Pn040 = n.□□0□ (Use the encoder resolution of the connected motor.)

Set the electronic gear ratio within the following range.

$$0.001 \leq \text{Electronic gear ratio (B/A)} \leq 64,000$$

If the electronic gear ratio is outside of this range, an A.040 alarm (Parameter Setting Error) will occur.

- Pn040 = n.□□1□ (Use a resolution of 20 bits when connected to an SGM7J, SGM7A, SGM7P, SGM7G, SGM7E, or SGM7F motor.)

Set the electronic gear ratio within the following range.

$$0.001 \leq \text{Electronic gear ratio (B/A)} \leq 4,000$$

If the electronic gear ratio is outside of this range, an A.040 alarm (Parameter Setting Error) will occur.

Pn20E	Electronic Gear Ratio (Numerator)				Position
	Setting Range	Setting Unit	Default Setting	When Enabled	Classification
	1 to 1,073,741,824	1	64	After restart	Setup
Pn210	Electronic Gear Ratio (Denominator)				Position
	Setting Range	Setting Unit	Default Setting	When Enabled	Classification
	1 to 1,073,741,824	1	1	After restart	Setup

Calculating the Settings for the Electronic Gear Ratio

◆ Rotary Servomotors

If the gear ratio between the Servomotor shaft and the load is given as n/m, where n is the number of load rotations for m Servomotor shaft rotations, the settings for the electronic gear ratio can be calculated as follows:

$$\text{Electronic gear ratio} \frac{B}{A} = \frac{\text{Pn20E}}{\text{Pn210}} = \frac{\text{Encoder resolution}}{\text{Travel distance per load shaft rotation (reference unit)}} \times \frac{m}{n}$$

6.2.1 Electronic Gear Settings

■ Encoder Resolution

You can check the encoder resolution in the Servomotor model number.

SGM7M -□□□□□□

Code	Specification	Encoder Resolution
3	20-bit multiturn absolute encoder	1,048,576

SGM7J, SGM7A,
SGM7P, SGM7G -□□□□□□

Code	Specification	Encoder Resolution
6	24-bit batteryless multiturn absolute encoder	16,777,216
7	24-bit multiturn absolute encoder	16,777,216
F	24-bit incremental encoder	16,777,216

SGM7E, SGM7F -□□□□□□

Code	Specification	Encoder Resolution
7	24-bit multiturn absolute encoder	16,777,216
F	24-bit incremental encoder	16,777,216

SGMCS -□□□□□□

Code	Specification	Encoder Resolution
3	20-bit single-turn absolute encoder	1,048,576
D	20-bit incremental encoder	1,048,576

SGMCV -□□□□□□

Code	Specification	Encoder Resolution
E	22-bit single-turn absolute encoder	4,194,304
I	22-bit multiturn absolute encoder	4,194,304

◆ Linear Servomotors

You can calculate the settings for the electronic gear ratio with the following equation:

When Not Using a Serial Converter Unit

Use the following formula if the linear encoder and SERVOPACK are connected directly or if a linear encoder that does not require a Serial Converter Unit is used.

$$\text{Electronic gear ratio } \frac{B}{A} = \frac{Pn20E}{Pn210} = \frac{\text{Travel distance per reference unit (reference units)} \times \text{Linear encoder resolution}}{\text{Linear encoder pitch (the value from the following table)}}$$

When Using a Serial Converter Unit

$$\text{Electronic gear ratio } \frac{B}{A} = \frac{Pn20E}{Pn210} = \frac{\text{Travel distance per reference unit (reference units)} \times \text{Resolution of the Serial Converter Unit}}{\text{Linear encoder pitch (setting of Pn282)}}$$

■ Feedback Resolution of Linear Encoder

The linear encoder pitches and resolutions are given in the following table.

Calculate the electronic gear ratio using the values in the following table.

Type of Linear Encoder	Manufacturer	Linear Encoder Model	Linear Encoder Pitch [μm] ^{*1}	Relay Device Model between SERVOPACK and Linear Encoder	Resolution	Resolution
Incremental	Dr. JOHANNES HEIDENHAIN GmbH	LIDA48□	20	JZDP-H003-□□□-E ^{*2}	256	0.078 μm
				JZDP-J003-□□□-E ^{*2}	4,096	0.0049 μm
		LIF48□	4	JZDP-H003-□□□-E ^{*2}	256	0.016 μm
				JZDP-J003-□□□-E ^{*2}	4,096	0.00098 μm
	Renishaw PLC	RGH22B	20	JZDP-H005-□□□-E ^{*2}	256	0.078 μm
				JZDP-J005-□□□-E ^{*2}	4,096	0.0049 μm
	Magnescale Co., Ltd.	SR75-□□□□□LF ^{*6}	80	—	8,192	0.0098 μm
				—	1,024	0.078 μm
		SR85-□□□□□LF ^{*6}	80	—	8,192	0.0098 μm
				—	1,024	0.078 μm
		SL700 ^{*6} , SL710 ^{*6} , SL720 ^{*6} , SL730 ^{*6}	800	PL101-RY ^{*3}	8,192	0.0977 μm
				MJ620-T13 ^{*4}		
	SQ10	400	MQ10-FLA ^{*4}	8,192	0.0488 μm	
			MQ10-GLA ^{*4}			
Canon Precision Inc.	PH03-36110	128	—	2,048	0.0625 μm	
	PH03-36120	128	—	2,048	0.0625 μm	
Absolute	Dr. JOHANNES HEIDENHAIN GmbH	LIC4100 Series ^{*7}	20.48	EIB3391Y ^{*5}	4,096	0.005 μm
		LIC2100 Series ^{*7}	204.8	EIB3391Y ^{*5}	4,096	0.05 μm
			409.6	EIB3391Y ^{*5}	4,096	0.1 μm
		LIC4190 Series	40.96	—	4,096	0.01 μm
			20.48	—	4,096	0.005 μm
			4.096	—	4,096	0.001 μm
		LIC3190 Series	40.96	—	4,096	0.01 μm
		LIC2190 Series	409.6	—	4,096	0.1 μm
	204.8		—	4,096	0.05 μm	
	LC115	40.96	EIB3391Y ^{*5}	4,096	0.01 μm	
	RSF Elektronik GmbH	MC15Y Series	409.6	—	4,096	0.1 μm
			204.8	—	4,096	0.05 μm
	Mitutoyo Corporation	ST781A/ST781AL	256	—	512	0.5 μm
		ST782A/ST782AL	256	—	512	0.5 μm
		ST783/ST783AL	51.2	—	512	0.1 μm
		ST784/ST784AL	51.2	—	512	0.1 μm
		ST788A/ST788AL	51.2	—	512	0.1 μm
		ST789A/ST789AL	25.6	—	512	0.05 μm
ST1381		5.12	—	512	0.01 μm	
ST1382		0.512	—	512	0.001 μm	
Renishaw PLC	EL36Y□□□050F□□□□	12.8	—	256	0.05 μm	
	EL36Y□□□100F□□□□	25.6	—	256	0.1 μm	
	EL36Y□□□500F□□□□	128	—	256	0.5 μm	
	RL36Y□□□050□□□□□□	12.8	—	256	0.05 μm	
	RL36Y□□□001□□□□□□	0.256	—	256	0.001 μm	

Continued on next page.

Continued from previous page.

Type of Linear Encoder	Manufacturer	Linear Encoder Model	Linear Encoder Pitch [μm]*1	Relay Device Model between SERVOPACK and Linear Encoder	Resolution	Resolution
Absolute	RLS d.o.o.	LA11YA Series	2,000	–	2,048	0.9765 μm
			2,000	–	4,096	0.4882 μm
			2,000	–	8,192	0.2441 μm
	Magnescale Co., Ltd.	SR77-□□□□□LF*6 SR77-□□□□□MF SR87-□□□□□LF*6 SR87-□□□□□MF SQ47/SQ57-□□□□□SF□□□□ SQ47/SQ57-□□□□□TF□□□□ SQ47/SQ57-□□□□□AF□□□□ SQ47/SQ57-□□□□□FF□□□□	80	–	8,192	0.0098 μm
			80	–	1,024	0.078 μm
			80	–	8,192	0.0098 μm
			80	–	1,024	0.078 μm
			20.48	–	4,096	0.005 μm
			40.96	–	4,096	0.01 μm
	Fagor Automation S. Coop.	L2AK208 L2AK211 LAK209 LAK212 S2AK208 SV2AK208 G2AK208 S2AK211 SV2AK211 G2AK211	20	–	256	0.078 μm
			20	–	2,048	0.0098 μm
			40	–	512	0.078 μm
			40	–	4,096	0.0098 μm
			20	–	256	0.078 μm
			20	–	256	0.078 μm
			20	–	256	0.078 μm
			20	–	2,048	0.0098 μm
			20	–	2,048	0.0098 μm
	Canon Precision Inc.	PH03-36E00	128	–	2,048	0.0625 μm

- *1. These are reference values for setting SERVOPACK parameters. Contact the manufacturer for actual linear encoder scale pitches.
- *2. This is the model of the Serial Converter Unit.
- *3. This is the model of the Head with Interpolator.
- *4. This is the model of the Interpolator.
- *5. This is the model of the Interface Unit.
- *6. If you use an encoder pulse output with this linear encoder, the setting range of the encoder output resolution (Pn281) is restricted. Refer to the following manual for details on the encoder output resolution (Pn281).
 Σ-7-Series Σ-7S SERVOPACK with MECHATROLINK-II Communications References Product Manual (Manual No.: SIEP S800001 27)
- *7. Sales of the interface unit EIB3391Y with the LIC4100 and LIC2100 series have ended due to the release of the LIC4190, LIC3190, and LIC2190 series.

Information

Resolution

You can calculate the resolution that is used inside the SERVOPACK (i.e., the travel distance per feedback pulse) with the following formula.

$$\text{Resolution (travel distance per feedback pulse)} = \frac{\text{Linear encoder pitch}}{\text{Resolution of Serial Converter Unit or linear encoder}}$$

The SERVOPACK uses feedback pulses as the unit to control a Servomotor.

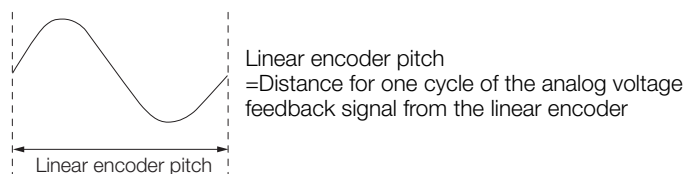

Electronic Gear Ratio Setting Examples

Setting examples are provided in this section.

- Rotary Servomotors

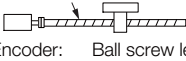
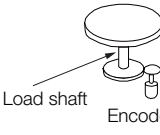
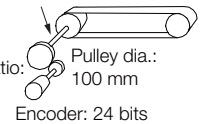
Step	Description	Machine Configuration		
		Ball Screw	Rotary Table	Belt and Pulley
		Reference unit: 0.001 mm Load shaft  Encoder: 24 bits Ball screw lead: 6 mm	Reference unit: 0.01° Load shaft  Gear ratio: 1/100 Encoder: 24 bits	Reference unit: 0.005 mm Load shaft  Gear ratio: 1/50 Pulley dia.: 100 mm Encoder: 24 bits
1	Machine Specifications	<ul style="list-style-type: none"> • Ball screw lead: 6 mm • Gear ratio: 1/1 	<ul style="list-style-type: none"> • Rotation angle per revolution: 360° • Gear ratio: 1/100 	<ul style="list-style-type: none"> • Pulley dia.: 100 mm (Pulley circumference: 314 mm) • Gear ratio: 1/50
2	Encoder Resolution	16,777,216 (24 bits)	16,777,216 (24 bits)	16,777,216 (24 bits)
3	Reference Unit	0.001 mm (1 μm)	0.01°	0.005 mm (5 μm)
4	Travel Distance per Load Shaft Revolution (Reference Units)	6 mm/0.001 mm = 6,000	360°/0.01° = 36,000	314 mm/0.005 mm = 62,800
5	Electronic Gear Ratio	$\frac{B}{A} = \frac{16,777,216}{6,000} \times \frac{1}{1}$	$\frac{B}{A} = \frac{16,777,216}{36,000} \times \frac{100}{1}$	$\frac{B}{A} = \frac{16,777,216}{62,800} \times \frac{50}{1}$
6	Parameters	Pn20E: 16,777,216	Pn20E: 1,677,721,600	Pn20E: 838,860,800
		Pn210: 6,000	Pn210: 36,000	Pn210: 62,800

- Linear Servomotors

A setting example for a Serial Converter Unit resolution of 256 is given below.

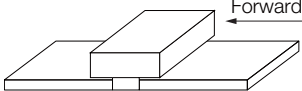
Step	Description	Machine Configuration
		 Reference unit: 0.02 mm (20 μm) Forward direction
1	Linear encoder pitch	0.02 mm (20 μm)
2	Reference Unit	0.001 mm (1 μm)
3	Electronic Gear Ratio	$\frac{B}{A} = \frac{1 (\mu\text{m})}{20 (\mu\text{m})} \times 256$
4	Setting Parameters	Pn20E: 256
		Pn210: 20

6.2.2 Motion Acceleration/Deceleration Function Setting

This section describes the parameters used to set the acceleration/deceleration function for motion commands for positioning.

Linear Acceleration/Deceleration Function

Use the following parameters to set the acceleration/deceleration constants used to execute POSING, FEED, EX_POSING, ZRET, or HOLD commands.

The setting of Pn833 = n.□□□X determines whether the settings of Pn80A to Pn80F and Pn827 are used or the settings of Pn834 to Pn840 are used.

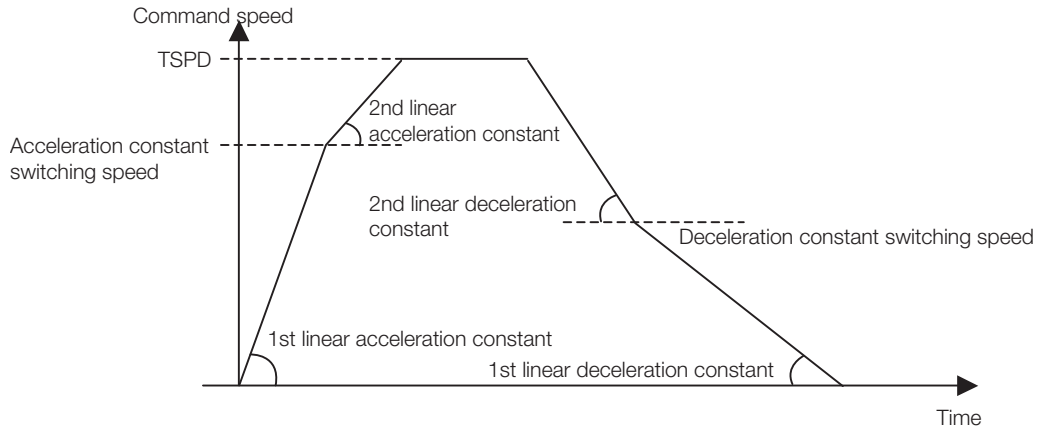

◆ Acceleration/Deceleration Constant Switching Setting

Parameter	Meaning	Factory Setting
Pn833 = n.□□□X	n.□□□0 Use Pn80A to Pn80F and Pn827. (The settings of Pn834 to Pn840 are ignored.)	n.□□□0
	n.□□□1 Use Pn834 to Pn840. (The settings of Pn80A to Pn80F and Pn827 are ignored.)	

Note: Any changes must be enabled by turning the power supply OFF and ON again or by sending a CONFIG command.

◆ Acceleration/Deceleration Parameters when Pn833=n.□□□0

Parameter No.	Name	Data Size (byte)	Setting Range	Unit	Factory Setting
Pn80A	First Stage Linear Acceleration Constant	2	1 to 65,535	10,000 reference units/s ²	100
Pn80B	Second Stage Linear Acceleration Constant	2	1 to 65,535	10,000 reference units/s ²	100
Pn80C	Acceleration Constant Switching Speed	2	0 to 65,535	100 reference units/s	0
Pn80D	First Stage Linear Deceleration Constant	2	1 to 65,535	10,000 reference units/s ²	100
Pn80E	Second Stage Linear Deceleration Constant	2	1 to 65,535	10,000 reference units/s ²	100
Pn80F	Deceleration Constant Switching Speed	2	0 to 65,535	100 reference units/s	0
Pn827	Linear Deceleration Constant 1 for Stopping	2	0 to 65,535	10,000 reference units/s ²	100

◆ Acceleration/Deceleration Parameters when Pn833=n.□□□1

Parameter No.	Name	Data Size (byte)	Setting Range	Unit	Factory Setting
Pn834	First Stage Linear Acceleration Constant 2	4	1 to 20,971,520	10,000 reference units/s ²	100
Pn836	Second Stage Linear Acceleration Constant 2	4	1 to 20,971,520	10,000 reference units/s ²	100
Pn838	Acceleration Constant Switching Speed 2	4	0 to 2,097,152,000	1 reference unit/s	0
Pn83A	First Stage Linear Deceleration Constant 2	4	1 to 20,971,520	10,000 reference units/s ²	100
Pn83C	Second Stage Linear Deceleration Constant 2	4	1 to 20,971,520	10,000 reference units/s ²	100
Pn83E	Deceleration Constant Switching Speed 2	4	0 to 2,097,152,000	1 reference unit/s	0
Pn840	Linear Deceleration Constant 2 for Stopping	4	0 to 20,971,520	10,000 reference units/s ²	100

Note: If the deceleration distance exceeds 1073741823 reference units during positioning, the motor cannot be accelerated to the target speed TSPD specified in the motion command. Set the parameter for deceleration speed to a value that satisfies the following equation.

$$\text{Deceleration speed [reference unit/s}^2] \geq \text{Max. command speed}^2 \text{ [reference unit/s]} / (\text{Max. deceleration distance [reference unit]} \times 2)$$

Position Reference Filter

A filter can be applied to the position reference output of a positioning command such as INTERPOLATE, LATCH, POSING, FEED, EX_POSINT, ZRET, and HOLD.

◆ Position Reference Filter Setting Parameters

Parameter No.	Name	Data Size (byte)	Setting Range	Unit	Factory Setting
Pn810	Exponential Acceleration/Deceleration Bias	2	0 to 65,535	100 reference units/s	0
Pn811	Exponential Acceleration/Deceleration Time Constant	2	0 to 5,100	0.1 ms	0
Pn812	Movement Average Time	2	0 to 5,100	0.1 ms	0

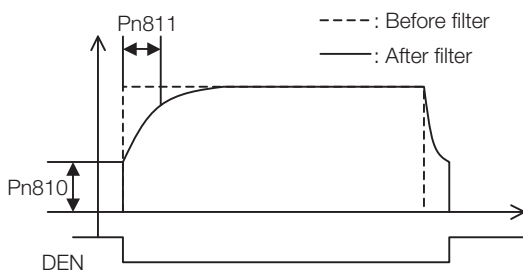

Exponential Function Acceleration/Deceleration Curve

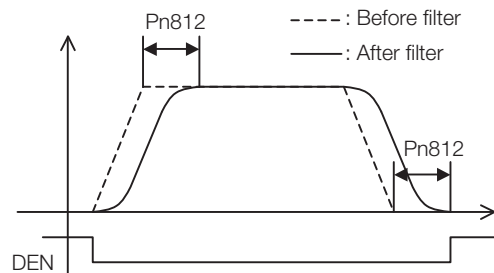

Movement Average Time Curve

◆ Position Reference Filter Type Selection

Use the ACCFIL bit of the OPTION field to specify the position reference filter type.

ACCFIL	Meaning
0	Without position reference filter
1	Exponential function acceleration/deceleration position reference filter
2	Movement average time position reference filter

Information While a position reference is being output (STATUS.DEN = 0), the parameter or the filter type cannot be changed. Wait for completion of the position reference output (STATUS.DEN = 1) to change the setting.

Linear Deceleration Speed Setting for Commands to Stop a Motor

Set the deceleration speed when using either of the following commands to stop a motor.

- HOLD (When HOLD_MOD = 2)
- SV_OFF (When Pn829 ≠ 0)

◆ Setting for Deceleration to a Stop by Executing HOLD Command (HOLD_MOD = 2)

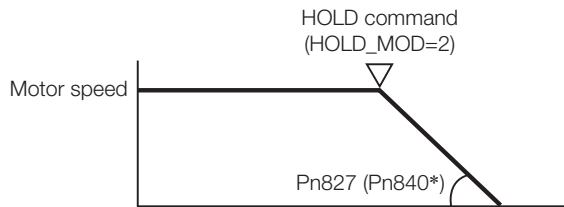

* Parameters in parentheses are used when Pn833 is set to 1.

Parameter No.	Name	Data Size (byte)	Setting Range	Unit	Factory Setting
Pn827	Linear Deceleration Constant 1 for Stopping	2	0 to 65,535	10,000 reference units/s ²	100
Pn840	Linear Deceleration Constant 2 for Stopping	4	0 to 20,971,520	10,000 reference units/s ²	100

◆ Setting for Deceleration to a Stop by Executing SV_OFF Command

When SV_OFF command is executed while a motor is running, the servo can be turned OFF after deceleration to a stop.

When Pn829 is set to 0 (factory setting), the servo will turn OFF immediately upon reception of the SV_OFF command.

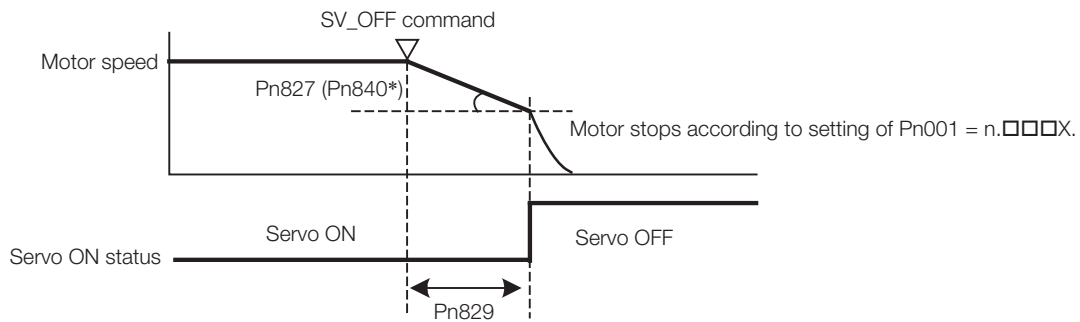

* Parameters in parentheses are used when Pn833 is set to 1.

Parameter No.	Name	Data Size (byte)	Setting Range	Unit	Factory Setting
Pn827	Linear Deceleration Constant 1 for Stopping	2	0 to 65,535	10,000 reference units/s ²	100
Pn829	SVOFF Waiting Time (for SVOFF at Deceleration to Stop)	2	0 to 65,535	10 ms	0
Pn840	Linear Deceleration Constant 2 for Stopping	4	0 to 20,971,520	10,000 reference units/s ²	100

6.2.3 Motion Sequence Setting

This section describes parameters related to the actions of EX_POSING and ZRET commands.

Settings for EX_POSING Command

Set the travel distance from the external signal input position to the final target position for execution of an EX_POSING command. If a negative value (distance to the negative direction) or a small value is set, the axis will decelerate to a stop and then move to the reverse direction for positioning.

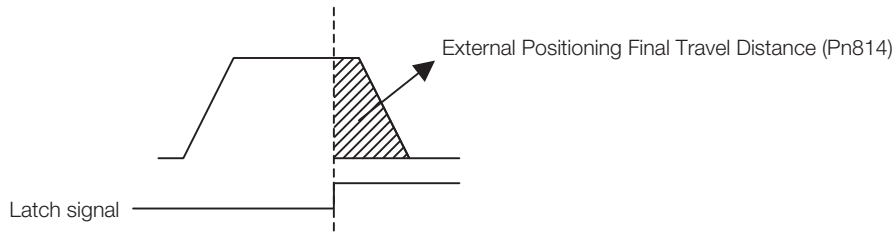

Parameter No.	Name	Data Size (byte)	Setting Range	Unit	Factory Setting
Pn814	External Positioning Final Travel Distance	4	-1,073,741,823 to 1,073,741,823	1 reference unit	100

Settings for ZRET Command

This section describes the parameters to set the following items for ZRET command.

- Pn816: Origin return direction selection
- Pn817 or Pn842: Approach speed after the origin limit signal is input (DEC signal turns ON)
- Pn818 or Pn844: Approach (creep) speed after the latch signal is input
- Pn819: Final travel distance from the latch signal input position to the origin

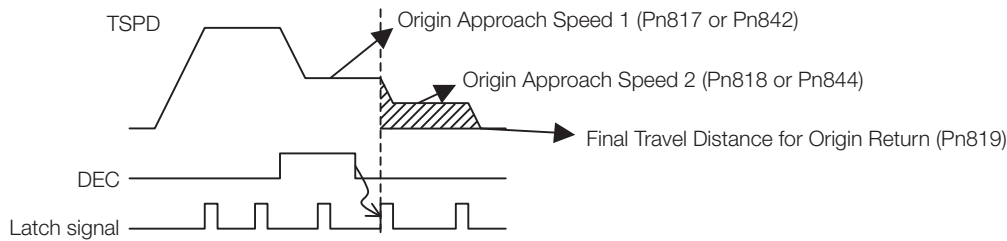

Parameter	Meaning	Factory Setting
Pn816	n.□□□0	Return in forward direction.
	n.□□□1	

Parameter No.	Name	Data Size (byte)	Setting Range	Unit	Factory Setting
Pn817	Origin Approach Speed 1, Second	2	0 to 65,535	100	50
Pn842	Origin Approach Speed 1 ^{*1}	4	0 to 20,971,520	reference units/s	0
Pn818	Origin Approach Speed 2, Second	2	0 to 65,535	100	5
Pn844	Origin Approach Speed 2 ^{*2}	4	0 to 20,971,520	reference units/s	0
Pn819	Final Travel Distance for Origin Return	4	-1,073,741,823 to 1,073,741,823	1 reference unit	100

*1. The value of Pn842 is effective only when the value of Pn817 is 0.

*2. The value of Pn844 is effective only when the value of Pn818 is 0.

- Information** Set Pn819 (Final Travel Distance for Origin Return) to a value that satisfies the following equation.
 When Pn816=n.□□□0: Origin = Latch signal input position + Pn819
 When Pn816=n.□□□1: Origin = Latch signal input position – Pn819

6.2.4 Command Data Options

Torque Limiting Function

The torque limiting function limits the output torque to protect the connected machine, etc. There are three ways to limit the output torque.

- Internal torque limit
- External torque limit using P_CL/N_CL signal of OPTION field
- Torque limit by position/speed control command

Information If all of the above three methods are used, the smallest torque limit will be applied.

◆ Internal Torque Limit

This method always limits the maximum output torque to the set values of the following parameters.

Parameter No.	Name	Data Size (byte)	Setting Range	Unit	Factory Setting
Pn402	Forward Torque Limit (For rotational servomotors)	2	0 to 800	1%	800
Pn403	Reverse Torque Limit (For rotational servomotors)	2	0 to 800	1%	800
Pn483	Forward Force Limit (For linear servomotors)	2	0 to 800	1%	30
Pn484	Reverse Force Limit (For linear servomotors)	2	0 to 800	1%	30

Information Set the limit value in percentage (%) of the motor rated torque.

◆ External Torque Limit Using P_CL/N_CL Signal of OPTION Field

This method uses the P_CL/N_CL signal of the OPTION field to limit the output torque to the set values of the following parameters.

Parameter No.	Name	Data Size (byte)	Setting Range	Unit	Factory Setting
Pn404	Forward External Torque Limit	2	0 to 800	1%	100
Pn405	Reverse External Torque Limit	2	0 to 800	1%	100

Information Set the limit value in percentage (%) of the motor rated torque.

◆ Torque Limit By Position/Speed Control Command

This methods limits the output torque by setting a desired limit value in the command data (TLIM/P_TLIM/N_TLIM).

■ Torque Limiting Function Settable Commands

INTERPOLATE, LATCH, FEED, EX_POSING, ZRET, and VELCTRL

■ Setting Parameters

Set the following parameters to apply a torque limit from a position/speed control command.

Pn81F = n.□□X□	Position Control Command TFF/TLIM Allocation	
	n.□□1□	Enable allocation (Set TFF/TLIM operation using Pn002.)
Pn002 = n.□□□X	MECHATROLINK Command Position and Speed Control Option	
	n.□□□1	Enable positive/negative torque limit by *TLIM.
	n.□□□3	Use TLIM/P_TLIM as positive torque limit when OPTION.P_CL=1. Use TLIM/N_TLIM as negative torque limit when OPTION.N_CL=1.

- Information**
- When using a torque limit set in a position control command, set Pn81F and Pn002 as follows:
Pn81F = n.□□1□, and Pn002 = n.□□□1 or n.□□□3
If Pn81F = n.□□0□, the torque limit set in the position control command will not applied.
 - When using a torque limit set in a speed control command, set Pn002 as follows.
Pn002 = n.□□□1 or n.□□□3
 - When a command other than the commands listed in [Torque Limiting Function Settable Commands], the torque limit of the previously executed TLIM/P_TLIM/N_TLIM remains valid. During execution of HOLD, SV_OFF, SVCTRL, or TRQCTRL command, the torque limit specified by TLIM/P_TRIM/N_TLIM is invalid.

Torque Feed Forward Function

This function is used to apply a torque feedforward (TFF) from a position/speed control command to shorten positioning time. The host controller differentiates a position reference to generate a torque feedforward reference.

■ Torque Feed Forward Reference Settable Commands

INTERPOLATE, LATCH, and VELCTRL

■ Relationship between the Host Controller and SERVOPACK

The following figures illustrate specifying torque feedforward in commands from the host controller when the SERVOPACK is performing speed control or position control.

• When SERVOPACK Performs Speed Control

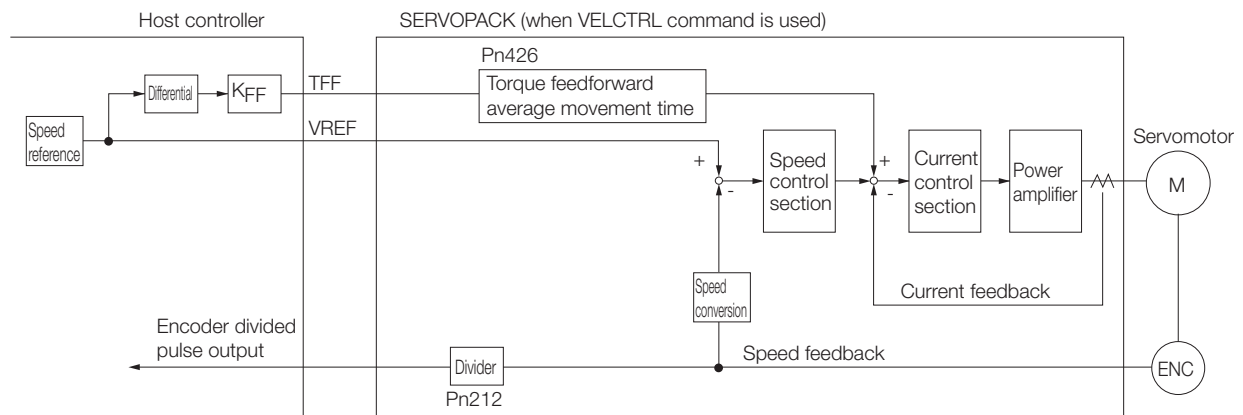

KFF: Feedforward gain

• When SERVOPACK Performs Position Control

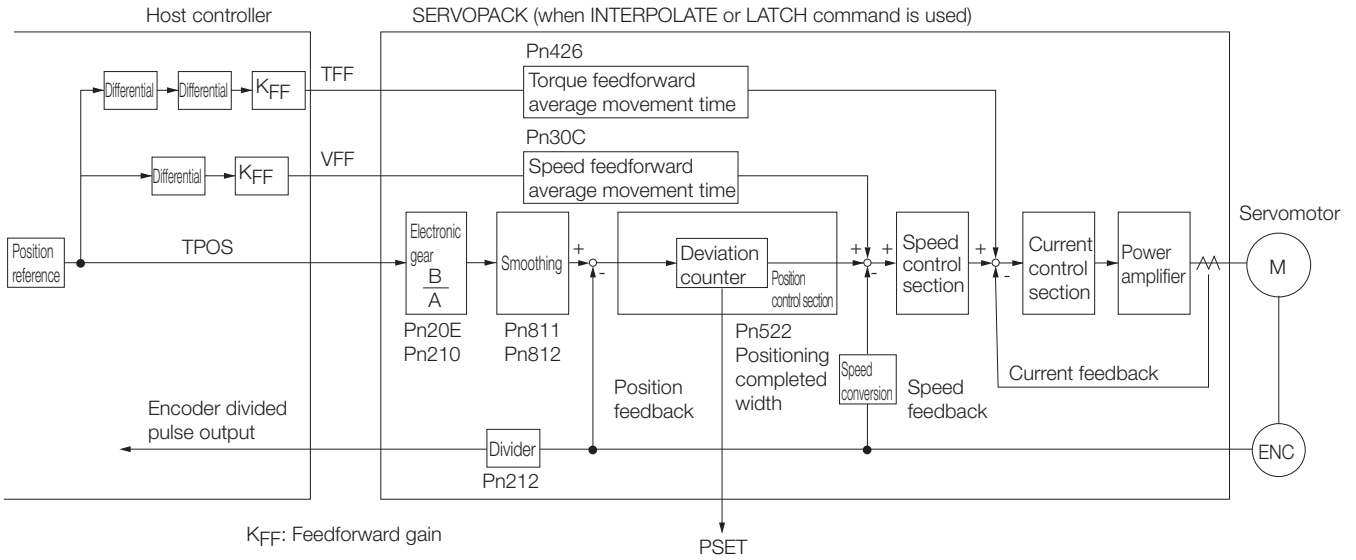

■ Setting Parameters

This section describes the parameters that are related to the torque feedforward reference.

• Pn81F (Position Control Command TFF/TLIM Allocation)

You must set Pn81F (Position Control Command TFF/TLIM Allocation) to use the torque feedforward reference. (The torque limit is enabled for the default setting.)

Parameter	Meaning	
Pn81F	Position Control Command TFF/TLIM Allocation	
	n.□□1□	Enable allocation. (The operation for TFF/TLIM is set in Pn002.)

• Pn426 (Torque Feedforward Average Movement Time)

If the communications cycle with the host controller is slow, the torque feedforward reference may be applied stepwise as shown on the left in the following figure.

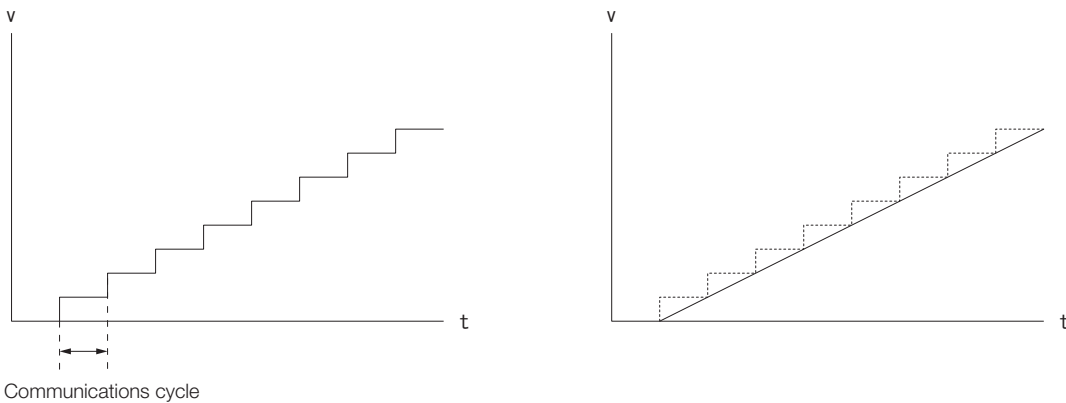

You can set Pn426 (Torque Feedforward Average Movement Time) to a suitable value to create a smooth torque feedforward reference, as shown on the right in the above figure.

As a guideline, set Pn426 to the same value as the communications cycle.

Pn426	Torque Feedforward Average Movement Time		<input type="checkbox"/> Speed	<input type="checkbox"/> Position	
	Setting Range	Setting Unit	Default Setting	When Enabled	Classification
	0 to 5,100	-	0	Immediately	Setup

Speed Feedforward Function

The speed feedforward function applies feedforward compensation to position control to shorten the positioning time. The speed feedforward reference is created from the differential of the position reference at the host controller. Speed feedforward is specified with VFF (speed feedforward) in the position control command.

■ Commands That Allow Speed Feedforward References

INTERPOLATE, LATCH

■ Relationship between the Host Controller and SERVOPACK

The following figure illustrates specifying speed feedforward in a command from the host controller when the SERVOPACK is performing speed control.

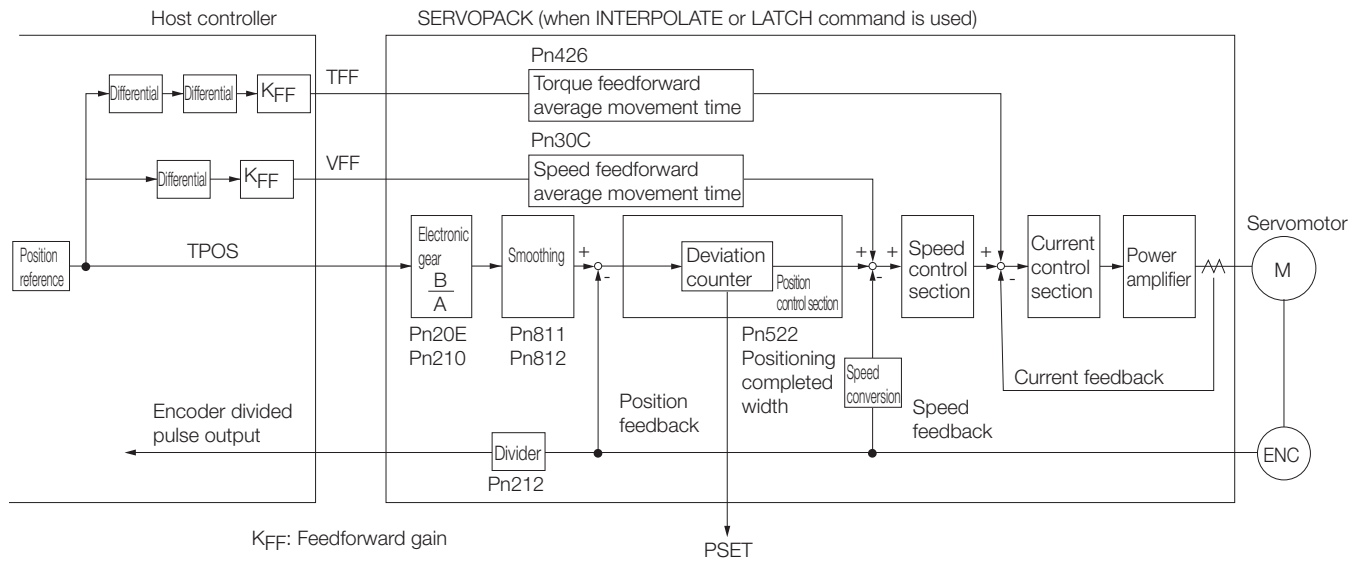

■ Pn30C (Speed Feedforward Average Movement Time)

If the communications cycle with the host controller is slow, the speed feedforward reference may be applied stepwise as shown on the left in the following figure.

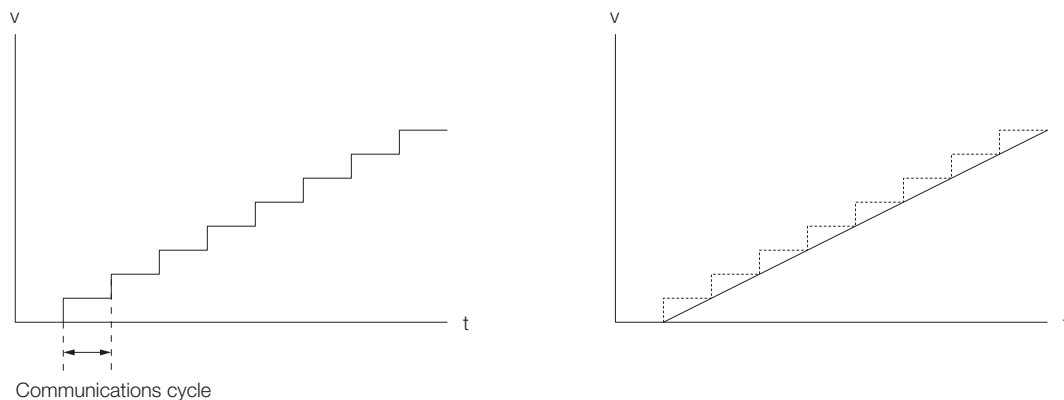

You can set Pn30C (Speed Feedforward Average Movement Time) to a suitable value to create a smooth speed feedforward reference, as shown on the right in the above figure.

As a guideline, set Pn30C to the same value as the communications cycle.

Pn30C	Speed Feedforward Average Movement Time		[Position]		
	Setting Range	Setting Unit	Default Setting	When Enabled	Classification
	0 to 5,100	-	0	Immediately	Setup

Speed Limiting Function During Torque Control

This function limits the servomotor speed during torque control to protect the connected machine, etc.

There are two ways to control the speed during torque control:

- Internal speed limit
- Speed limit by the torque control command TRQCTRL

Information If both of the above methods are used, the smaller speed limit will be applied.

◆ Internal Speed Limit

This method always limits the servomotor speed to either of the following set parameter values.

Parameter No.	Name	Data Size (byte)	Setting Range	Unit	Factory Setting
Pn407	Speed Limit during Toque Control (For rotational servomotors)	2	0 to 10,000	1 min ⁻¹	10,000
Pn480	Speed Limit during Force Control (For linear servomotors)	2	0 to 10,000	1 mm/s	10,000

◆ Speed Limit by Torque Control Command TRQCTRL

This method limits the speed by setting a desired speed limit value in the command data (VLIM).

Set the following parameter to use the speed limit set in TRQCTRL command.

Pn002 = n.□□X□	Torque Control Option	
	n.□□0□	Ignore the setting of the speed limit for torque control (VLIM).
	n.□□1□	Use the speed limit for torque control (VLIM) as the speed limit.

OPTION Field Allocation

The commands can be allocated to the OPTION field using the following parameters. To change the factory setting, set Pn81F = □□□1 and allocate the function bits using parameters Pn82A to Pn82E. Any changes must be enabled by turning the power supply OFF and ON again or by sending a CONFIG command.

Parameter		Name		Setting Range	Factory Setting	
No.	Digit					
Pn81F		Command Data Allocations		0000 hex to 0011 hex	0000 hex	
	0	Option Field Allocation		0 or 1	0	
		0	Disable option field allocation.			
	1	Enable option field allocation.				
Pn82A		Option Field Allocations 1		0000 hex to 1E1E hex	1813 hex	
	0	0 to E	ACCFIL bit position	–	3	
		0	Disable ACCFIL bit allocation.		–	1
	1	1	Enable ACCFIL bit allocation.			
	2	0 to E	G_SEL bit position		–	8
		0	Disable G_SEL bit allocation.			
3	1	Enable G_SEL bit allocation.		–	1	

Continued on next page.

6.2 Command Related Parameters Details

6.2.4 Command Data Options

Continued from previous page.

Parameter		Name		Setting Range	Factory Setting
No.	Digit				
Pn82B		Option Field Allocations 2		0000 hex to 1F1F hex	1D1C hex
	0	0 to F	V_PPI bit position	–	C
1	0		Disable V_PPI bit allocation	–	1
	1		Enable V_PPI bit allocation.		
	2	0 to F	P_PI_CLR bit position	–	D
3	0		Disable P_PI_CLR bit allocation.	–	1
	1		Enable P_PI_CLR bit allocation.		
Pn82C		Option Field Allocation 3		0000 hex to 1F1F hex	1F1E hex
	0	0 to F	P_CL bit position	–	E
1	0		Disable P_CL bit allocation.	–	1
	1		Enable P_CL bit allocation.		
	2	0 to F	N_CL bit position	–	F
3	0		Disable N_CL bit allocation.	–	1
	1		Enable N_CL bit allocation.		
Pn82D		Option Field Allocation 4		0000 hex to 1F1C hex	0000 hex
	0	0 to C	BANK_SEL1 bit position	–	0
1	0		Disable BANK_SEL1 bit allocation.	–	0
	1		Enable BANK_SEL1 bit allocation.		
	2	0 to F	LT_DISABLE bit position	–	0
3	0		Disable LT_DISABLE bit allocation.	–	0
	1		Enable LT_DISABLE bit allocation.		
Pn82E		Option Field Allocation 5		0000 hex to 1D1F hex	0000 hex
	0	0 to F	Reserved	–	0
1	0		Reserved	–	0
	1		Reserved		
	2	0 to D	OUT_SIGNAL bit position	–	0
3	0		Disable OUT_SIGNAL bit allocation.	–	0
	1		Enable OUT_SIGNAL bit allocation.		

Note: 1. Do not allocate more than one signal to one bit. If more than one signal is allocated to one bit, the bit will control more than one signal.

2. An unallocated function bit acts as if it is set to 0.

3. Set the bit to the least significant bit position to be allocated.

4. To enable the OUT_SIGNAL function, set the following parameters to ZERO: Pn50E, Pn50F, and Pn510.

6.2.5 Position Data Latch Function Setting

This section describes the parameters for setting the position data latch function.

Latching Allowable Area

Use the following parameters to set the range to input the latch signal for position data latching by LTMOD_ON, LATCH, EX_POSING, or ZRET command. If the latch signal is input out of the set range, position data will not be latched.

The latching region is set with the following parameters.

Parameter No.	Name	Data Size (byte)	Setting Range	Unit	Factory Setting
Pn820	Forward Latching Area	4	-2,147,483,648 to 2,147,483,647	1 reference unit	0
Pn822	Reverse Latching Area	4	-2,147,483,648 to 2,147,483,647	1 reference unit	0

■ When Pn820 > Pn822

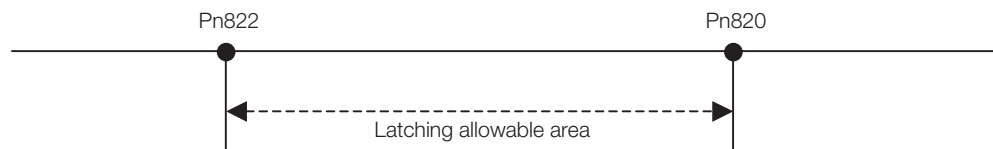

■ When Pn820 ≤ Pn822



Continuous Latch Function

This function sequentially latches the input positions of sequence signal 1 to sequence signal n ($n = 1$ to 8) for a specified number of times. The continuous latch operation can be aborted by executing the LTMOD_OFF command. This function can shorten the time between latch completion and the start of the next latch, and enables sequential latch operations at high speed.

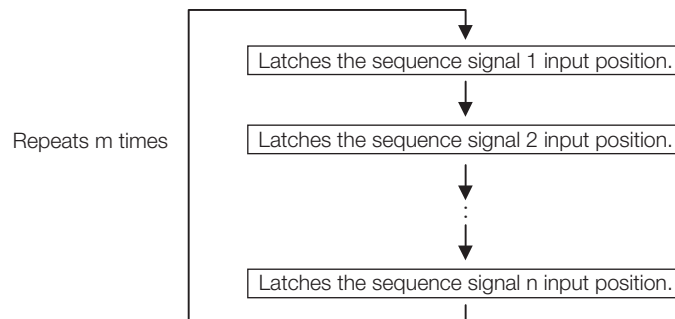

- Note 1: N, the number of sequence signals, is specified in Pn850.
 2: The signals for sequence signal n are selected with Pn852 and Pn853
 3: M, the number of continuous latches is set in Pn851.

■ How to Start and Stop Continuous Latch Operation

Set the following parameters, and then set LT_MOD to 1 to execute the LTMOD_ON command. The continuous latch operation will start. To abort the operation, execute the LTMOD_OFF command.

Pn850: Number of Latch Sequences n

Pn851: Continuous Latch Sequence Count m (When m = 0, the continuous latch operation will be infinitely repeated.)

Pn852: Latch Sequence 1 to 4 Settings

Pn853: Latch Sequence 5 to 8 Settings

Note: If the LTMOD_ON command is sent when Pn850 is set to 0 and LT_MOD is 1, an A.94E alarm (Data Setting Warning 5 (Latch Mode Error)) will occur and latching will not be started.

■ Latch Status

Latch completion can be confirmed by the following status.

• STATUS Field: The 3rd and 4th byte

L_CMP (D10): L_CMP is set to 1 for one communications cycle every time the external signal is input.

• EX_STATUS Field: The 28th and 29th byte

L_SEQ_NO (D8-D11): The latch sequence signal number (value n) at latch completion

L_CMP_CNT (D0-D7): The continuous latch count (value m)
(Added at completion of position latch when the latch sequence signal n is input.)

Note: LPOS is forcibly output to MONITOR 2 for one communications cycle while L_CMP = 1 every time the external signal is input.

■ Operation Example

An example of a continuous latch operation using two latch sequence signals EXT1 and EXT2 is illustrated below. (Parameter settings: Pn850 = 2, Pn851 = 2 or higher, Pn852 = 0021 hex, and Pn853 = any value)

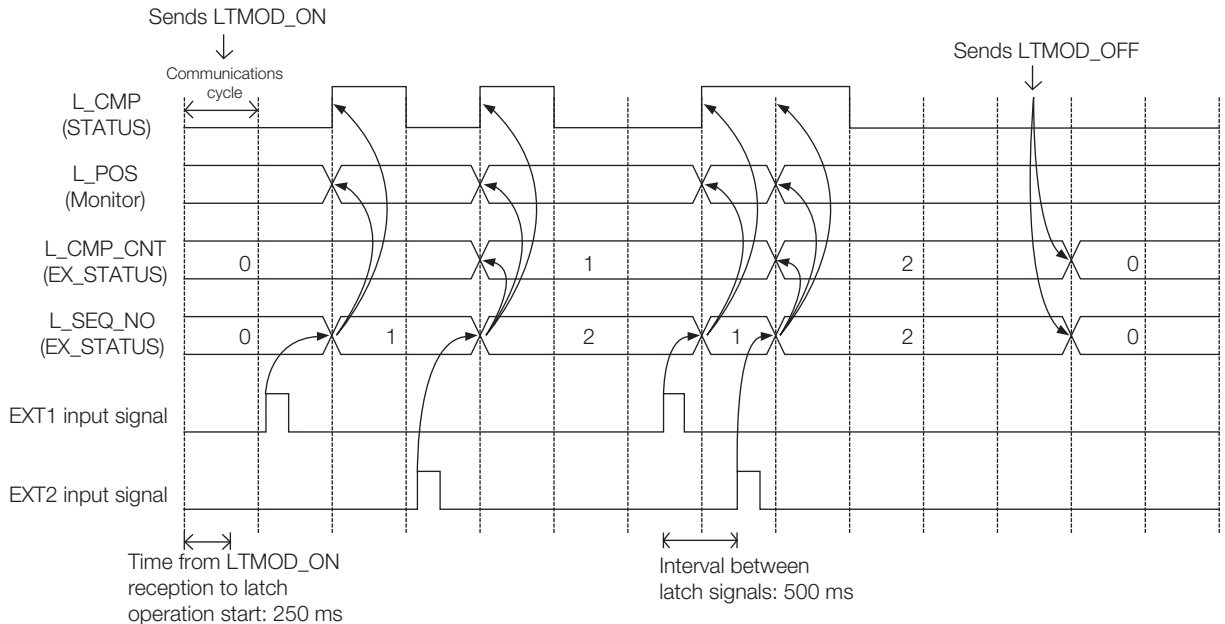

■ Setting Parameters

Parameter		Name	Data Size (byte)	Setting Range	Unit	Factory Setting		
No.	Digit							
Pn850		Number of Latch Sequences	2	0 to 8	–	0		
Pn851		Continuous Latch Sequence Count	2	0 to 255	–	0		
Pn852		Latch Sequence 1 to 4 Settings	2	0000 hex to 3333 hex	–	0000 hex		
	0	Latch Sequence 1 Signal Selection	0	Phase C	–	0 to 3	–	0
			1	EXT1 signal				
			2	EXT2 signal				
			3	EXT3 signal				
	1	Latch Sequence 2 Signal Selection	0	Phase C	–	0 to 3	–	0
			1	EXT1 signal				
			2	EXT2 signal				
			3	EXT3 signal				
	2	Latch Sequence 3 Signal Selection	0	Phase C	–	0 to 3	–	0
			1	EXT1 signal				
			2	EXT2 signal				
			3	EXT3 signal				
	3	Latch Sequence 4 Signal Selection	0	Phase C	–	0 to 3	–	0
			1	EXT1 signal				
			2	EXT2 signal				
			3	EXT3 signal				
Pn853		Latch Sequence 5 to 8 Settings	2	0000 hex to 3333 hex	–	0000 hex		
	0	Latch Sequence 5 Signal Selection	0	Phase C	–	0 to 3	–	0
			1	EXT1 signal				
			2	EXT2 signal				
			3	EXT3 signal				
	1	Latch Sequence 6 Signal Selection	0	Phase C	–	0 to 3	–	0
			1	EXT1 signal				
			2	EXT2 signal				
			3	EXT3 signal				
	2	Latch Sequence 7 Signal Selection	0	Phase C	–	0 to 3	–	0
			1	EXT1 signal				
			2	EXT2 signal				
			3	EXT3 signal				
	3	Latch Sequence 8 Signal Selection	0	Phase C	–	0 to 3	–	0
			1	EXT1 signal				
			2	EXT2 signal				
			3	EXT3 signal				

■ Application Notes

- The minimum interval between latch signals is 500 μ s. An interval between latch signals that is longer than the communications cycle is required to continuously obtain latched position data.
- If two latch signals are input without allowing the minimum required interval, only the first latch signal input position will be latched. The second latch signal will be ignored.
- Use a subcommand to monitor completion status of continuous latch count, etc.
- If you change the settings of Pn850 to Pn853, do so while consecutive latching is stopped.

6.2.6 Settings for Acceleration/Deceleration Parameter High-speed Switching

This function switches, at high-speed, the acceleration/deceleration parameters that are used for positioning executed by the POSING, FEED, EX_POSING, ZRET, or HOLD commands.

Register the acceleration/deceleration parameter settings in a bank before starting operation, and execute the bank selector BANK_SEL to switch the acceleration/deceleration parameter settings to those of the registered bank.

◆ Bank Selector Allocation

Allocate the following bank selector BANK_SEL1 in the OPTION field. (The allocation is disabled by default.)

 Refer to 2.1.2 OPTION Field Specifications on page 2-3

Name	Description	Setting Data
BANK_SEL1	Bank selector	Bank 0 to 15

◆ Parameter Bank Setting

Set the following parameters.

Parameter No.	Name	Data Size (byte)	Setting Range	Factory Setting
Pn900	Number of Parameter Banks	2	0 to 16	0
Pn901	Number of Parameter Bank Members	2	0 to 15	0
Pn902 to Pn910	Parameter Bank Member Definition	2	0000 hex to 08FF hex	0
Pn920 to Pn95F *	Parameter Bank Data	2	0000 hex to FFFF hex Depends on bank member.	0

* The parameters Pn920 to Pn95F will not be stored in the non-volatile memory. They need to be set every time the power is turned ON.

◆ Parameters that Can be Registered as Bank Members

The following parameters can be registered as parameter bank members among parameters Pn902 to Pn910.

For 4-byte parameters, one parameter must be registered as two consecutive members. (See Setting Example 2.)

Parameter No.	Name	Data Size (byte)	Setting Range	Unit	Factory Setting
Pn80A	First Stage Linear Acceleration Constant	2	1 to 65,535	10,000 reference units/s ²	100
Pn80B	Second Stage Linear Acceleration Constant	2	1 to 65,535	10,000 reference units/s ²	100
Pn80C	Acceleration Constant Switching Speed	2	0 to 65,535	100 reference units/s	0
Pn80D	First Stage Linear Deceleration Constant	2	1 to 65,535	10,000 reference units/s ²	100
Pn80E	Second Stage Linear Deceleration Constant	2	1 to 65,535	10,000 reference units/s ²	100
Pn80F	Deceleration Constant Switching Speed	2	0 to 65,535	100 reference units/s	0
Pn834	First Stage Linear Acceleration Constant 2	4	1 to 20,971,520	10,000 reference units/s ²	100

Continued on next page.

Continued from previous page.

Parameter No.	Name	Data Size (byte)	Setting Range	Unit	Factory Setting
Pn836	Second Stage Linear Acceleration Constant 2	4	1 to 20,971,520	10,000 reference units/s ²	100
Pn838	Acceleration Constant Switching Speed 2	4	0 to 2,097,152,000	1 reference unit/s	0
Pn83A	First Stage Linear Deceleration Constant 2	4	1 to 20,971,520	10,000 reference units/s ²	100
Pn83C	Second Stage Linear Deceleration Constant 2	4	1 to 20,971,520	10,000 reference units/s ²	100
Pn83E	Deceleration Constant Switching Speed 2	4	0 to 2,097,152,000	1 reference unit/s	0
Pn810	Exponential Acceleration/Deceleration Bias	2	0 to 65,535	100 reference units/s	0
Pn811	Exponential Acceleration/Deceleration Time Constant	2	0 to 5,100	0.1 ms	0
Pn812	Movement Average Time	2	0 to 5,100	0.1 ms	0

◆ Setting Procedure

1. Set Pn900 (Number of Parameter Banks) to m.
2. Set Pn901 (Number of Parameter Bank Members) to n.
Set Pn900 and Pn901 so that $Pn900 \times Pn901 \leq 64$.
3. Register bank member parameter numbers using parameters Pn902 to Pn910.
4. To enable the bank function, execute the CONFIG command or turn the power supply OFF and then ON again.
5. Set the data of each bank in the parameter bank data area from the leading parameter Pn920 in order as shown below.
Bank 0: Pn920 to Pn (920+n-1)
Bank 1: Pn (920+n) to Pn (920+2n-1)
...
Bank m-1: Pn {920+(m-1)×n} to Pn (920+m×n-1)

Note: 1. If parameters Pn900 to Pn910 set in STEP 1, 2, and 3 are saved in the non-volatile memory, carry out STEP 5 only after power up.
However, if bank data is set in Pn920 to Pn95F and you turn the power supply OFF and ON again after setting Pn900 to Pn910 (banks enabled), operation will be performed with all bank data set to 0 or to the minimum setting.

2. If parameters Pn900 to Pn910 set in STEP 1.1, 1.2, and 1.3 are not saved in the non-volatile memory, carry out STEP 1.1 to 2.5 each time the power supply is turned ON.

Example Switching Three Banks with the Following Members: Pn80B, Pn80E, and Pn80C

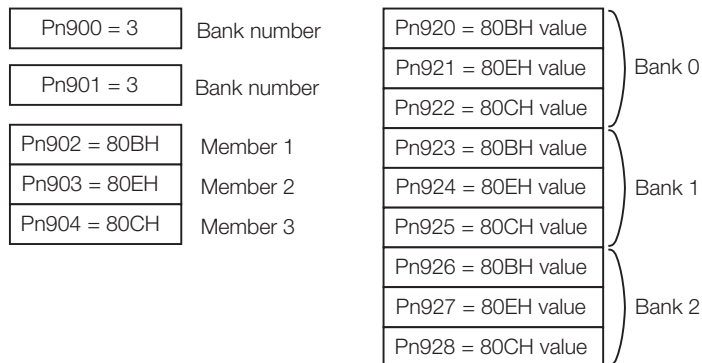

Example Switching Two Banks with the Following Members: Pn836, Pn83C, and Pn838

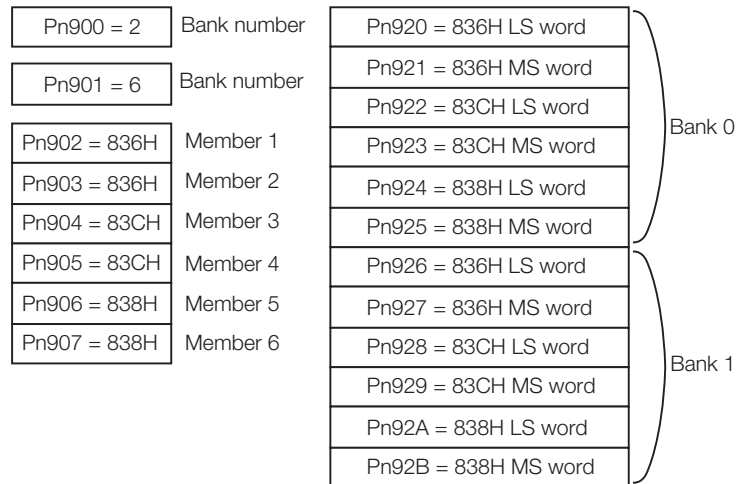

■ Application Notes

- If Pn900 (Number of Parameter Banks) or Pn901 (Number of Parameter Bank Members) is set to 0, the bank function will be disabled.
- If one parameter is registered for more than one bank member definition, the bank data of the biggest bank member definition parameter number will be applied.
- If the bank selector BANK_SEL is not allocated to the function bit of the OPTION field, the data of Bank 0 will be always applied.
- The acceleration/deceleration parameter high-speed switching function is enabled only while DEN = 1 (Distribution Completed). The parameters will not switch while DEN = 0 (Distributing).
- In the following cases, an A.04A alarm (Parameter Setting Error 2) will occur when the power supply is turned ON or the CONFIG command is executed.
 - One 4-byte parameter is not registered for two bank members.
 - The total number of bank data entries exceeds 64 ($Pn900 \times Pn901 > 64$).
- If a parameter that is not allowed to be a bank member is registered, the bank data of the parameter-registered member will become invalid.
- Bank data that exceeds the setting range of the registered bank member parameter will be clamped to a value within the setting range.
- If a bank number larger than the bank number set in Pn900 is specified ($BANK_SEL1 \geq Pn900$), the parameter bank will not switch and the currently active bank will be used.
- Parameters Pn920 to Pn95F will not be saved in the non-volatile memory. Therefore, they must be set each time the power supply is turned ON.

6.2.7 STATUS Field and Monitor Related Settings

STATUS Field Status Detection Level Setting

This section describes the parameters for setting the status detection levels for the STATUS field data.

◆ Origin (ZPOINT) Range Setting

Set the ZPOINT signal status detection range.

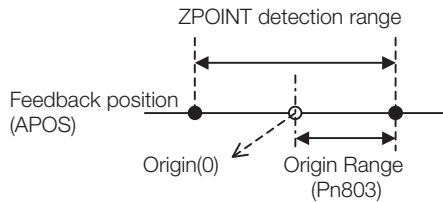

Parameter No.	Name	Data Size (byte)	Setting Range	Unit	Factory Setting
Pn803	Origin Range	2	0 to 250	1 reference unit	10

Information ZPOINT detection will be performed only after completion of the following operations. Otherwise, it will not be performed.

■ When an incremental encoder is connected

- The origin return operation by ZRET command is completed.
- The coordinate setting is completed after reference point setting (REFE = 1) by executing POS_SET command.

■ When an absolute encoder is connected

- Execution of SENS_ON command is completed.

◆ Positioning Completed (PSET) Width Setting

Set the PSET signal status detection range.

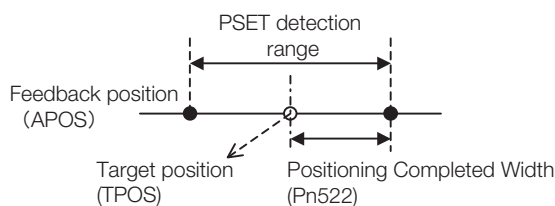

Parameter No.	Name	Data Size (byte)	Setting Range	Unit	Factory Setting
Pn522	Positioning Completed Width	4	0 to 1,073,741,824	1 reference unit	7

Information PSET = 1 when output is completed (DEN = 1) and the feedback position (APOS) is within the positioning completed (PSET) detection range.

◆ NEAR Signal Width Setting

Set the NEAR signal status detection range.

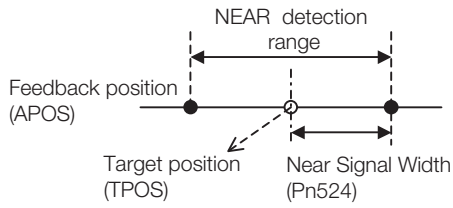

Parameter No.	Name	Data Size (byte)	Setting Range	Unit	Factory Setting
Pn524	Near Signal Width	4	0 to 1,073,741,824	1 reference unit	7

Information NEAR = 1 when the feedback position (APOS) is within the NEAR signal detection range.

◆ Zero-speed (ZSPD) Detection Level Setting

Set the ZSPD signal status detection level during speed control (VELCTRL command).

Parameter No.	Name	Data Size (byte)	Setting Range	Unit	Factory Setting
Pn502	Rotation Detection Level (For rotational servomotors)	2	1 to 10,000	1 min ⁻¹	20
Pn581	Zero Speed Level (For linear servomotors)	2	1 to 5,000	1 mm/s	20

◆ Speed Coincidence (VCMP) Detection Level Setting

Set the VCMP signal status detection level during speed control (VELCTRL command).

Parameter No.	Name	Data Size (byte)	Setting Range	Unit	Factory Setting
Pn503	Speed Coincidence Detection Signal Output Width (For rotational servomotors)	2	0 to 100	1 min ⁻¹	10
Pn582	Speed Coincidence Detection Signal Output Width (For linear servomotors)	2	0 to 100	1 mm/s	10

I/O Monitor Field Signal Allocation

You can allocate CN1 connector input signals to bits D12 to D15 of the I/O monitor field.

Parameter		Function	Setting	Allocation	Factory Setting
No.	Digit				
Pn81E	0	IO12 Signal Mapping	0	Do not map.	0
			1	Monitor the CN1-13 input terminal	
			2	Monitor the CN1-7 input terminal	
			3	Monitor the CN1-8 input terminal	
			4	Monitor the CN1-9 input terminal	
			5	Monitor the CN1-10 input terminal	
			6	Monitor the CN1-11 input terminal	
			7	Monitor the CN1-12 input terminal	
	1	IO13 Signal Mapping	1 to 7	Refer to IO12 signal mapping	0
	2	IO14 Signal Mapping	1 to 7	Refer to IO12 signal mapping	0
3	IO15 Signal Mapping	1 to 7	Refer to IO12 signal mapping	0	

Option Monitor Setting

Set the contents to be monitored when Option Monitor 1 and Option Monitor 2 are selected for MONITOR 1/2/3/4.

Parameter No.	Name	Remarks
	Option Monitor 1 Selection	–
	0000 hex Motor speed [1000000 hex/overspeed detection speed]	–
	0001 hex Speed reference [1000000 hex/overspeed detection speed]	–
	0002 hex Torque [1000000 hex/maximum torque]	–
	0003 hex Position deviation (lower 32 bits) [reference units]	–
	0004 hex Position deviation (upper 32 bits) [reference units]	–
	0005 hex System reserved	–
	0006 hex System reserved	–
	000A hex Encoder count (lower 32 bits) [reference units]	–
	000B hex Encoder count (upper 32 bits) [reference units]	–
Pn824	000C hex FPG count (lower 32 bits) [reference units]	For fully-closed loop control
	000D hex FPG count (upper 32 bits) [reference units]	For fully-closed loop control
	0010 hex Un000: Motor speed [min^{-1}]	–
	0011 hex Un001: Speed Reference [min^{-1}]	–
	0012 hex Un002: Torque Reference [%]	–
	0013 hex Un003: Rotational Angle 1 [encoder pulses]	–
	0014 hex Un004: Rotational Angle 2 [deg]	–
	0015 hex Un005: Input Signal Monitor	–
	0016 hex Un006: Output Signal Monitor	–
	0017 hex Un007: Input Reference Speed [min^{-1}]	–
	0018 hex Un008: Position Deviation [reference units]	–
	0019 hex Un009: Accumulated Load Ratio [%]	–
	001A hex Un00A: Regenerative Load Ratio [%]	–
	001B hex Un00B: Dynamic Brake Resistor Power Consumption [%]	–

Continued on next page.

6.2 Command Related Parameters Details

6.2.7 STATUS Field and Monitor Related Settings

Continued from previous page.

Parameter No.	Name		Remarks
Pn824	001C hex	Un00C: Input Reference Pulse Counter [reference units]	-
	001D hex	Un00D: Feedback Pulse Counter [encoder pulses]	-
	001E hex	Un00E: Fully-Closed Loop Feedback Pulse Counter [external encoder resolution]	For fully-closed loop control
	0023 hex	Initial multiturn data [rev]	For rotational servomotors
	0024 hex	Initial incremental data [pulses]	For rotational servomotors
	0025 hex	Initial absolute position data (lower 32 bits) [pulses]	For linear servomotors
	0026 hex	Initial absolute position data (upper 32 bits) [pulses]	For linear servomotors
	0027 hex	Reserved parameter (Do not use.)	-
	002A hex	Un032: Instantaneous Power	-
	002B hex	Un033: Power Consumption	-
	002C hex	Un034: Cumulative Power Consumption	-
	0030 hex	Reference position in reference coordinate system after reference filter (upper 32 bits)	-
	0031 hex	Reference position (upper 32 bits)	-
	0032 hex	Position deviation (upper 32 bits)	-
	0033 hex	Feedback position in machine coordinate system (upper 32 bits)	-
	0034 hex	Latched feedback position in machine coordinate system (upper 32 bits)	-
	0035 hex	Reference position in reference coordinate system before reference filter (upper 32 bits)	-
	0036 hex	Reference position in reference coordinate system (upper 32 bits)	-
	003A hex	Un025: SERVOPACK installation Environment Monitor	-
	003B hex	Un026: Servomotor installation Environment Monitor	-
	0040 hex	Built-in fan consumed life ratio	-
	0041 hex	Capacitor consumed life ratio	-
	0042 hex	Surge prevention circuit consumed life ratio	-
	0043 hex	Dynamic brake circuit consumed life ratio	-
	0080 hex	Previous value of latched feedback position (LPOS) [encoder pulses]	-
	Others	Reserved parameters (Do not use.)	-
	Pn825	Option Monitor 2 Selection (Same as for Pn824)	

Detecting Alarms/ Warnings Related to Communications or Commands



This chapter describes the alarms and warnings that may occur in MECHATROLINK-II communications. Refer to your SERVOPACK manual for details on alarms and alarm codes that are not given in this manual.

7.1	List of Alarms	7-2
7.2	List of Warnings	7-5
7.3	Monitoring Communication Data on Occurrence of an Alarm or Warning .	7-7

7.1 List of Alarms

The following table shows alarms that are related to communications or commands and that may occur in MECHATROLINK-II communications.

If an error is found in the command or data that a SERVOPACK has received, the SERVOPACK returns the corresponding alarm number.

At the same time, the alarm number is displayed on the SERVOPACK.

◆ Servomotor Stopping Method

If an alarm occurs, the servomotor can be stopped by doing either of the following operations.

Gr.1: If an alarm occurs, the Servomotor is stopped according to the setting of Pn001 = n.□□□X. Pn001.0 is factory-set to stop the servomotor by applying the DB.

Gr.2: If an alarm occurs, the Servomotor is stopped according to the setting of Pn00B = n.□□X□. Pn00B.1 is factory-set to stop the servomotor by setting the speed reference to "0." The servomotor under torque control will always use the Gr.1 method to stop. If you set Pn00B to n.□□1□, the same stopping method as for Gr.1 is used. When coordinating a number of servomotors, use this stopping method to prevent machine damage that may result due to differences in the stop method.

◆ Alarm Reset

Available: Removing the cause of alarm and then executing the alarm reset can clear the alarm.

N/A: Executing the alarm reset cannot clear the alarm.

Alarm Number: Alarm Name (Alarm Description)	Cause	Investigative Actions	Corrective Actions	SERVOPACK Side	
				Servomotor Stopping Method	Alarm Reset
A.b6A: MECHATROLINK Communications ASIC Error 1	SERVOPACK MECHATROLINK communication section fault.	–	Replace the SERVO-PACK.	Gr.1	N/A
A.E02: MECHATROLINK Internal Synchronization Error 1	MECHATROLINK-II transmission cycle fluctuated.	–	Remove the cause of transmission cycle fluctuation at host controller.	Gr.1	Available
	A SERVOPACK fault occurred.	–	Turn the power supply OFF and then ON again. If the alarm still occurs, the SERVO-PACK may be faulty. Replace the SERVO-PACK.		
A.E40: MECHATROLINK Transmission Cycle Setting Error	Setting of MECHATROLINK-II transmission cycle is out of specifications range.	Check the MECHATROLINK-II transmission cycle setting.	Set the transmission cycle to the proper value.	Gr.2	Available
A.E50: MECHATROLINK Synchronization Error	WDT data of host controller was not updated correctly.	Check the WDT data updating for the host controller.	Update the WDT data at the host controller correctly.	Gr.2	Available
	A SERVOPACK fault occurred.	–	Turn the power supply OFF and then ON again. If the alarm still occurs, the SERVO-PACK may be faulty. Replace the SERVO-PACK.		

Continued on next page.

Continued from previous page.

Alarm Number: Alarm Name (Alarm Description)	Cause	Investigative Actions	Corrective Actions	SERVOPACK Side	
				Servomotor Stopping Method	Alarm Reset
A.E51: MECHATROLINK Synchronization Failed	WDT data of host controller was not updated correctly at the synchronization communications start, and synchronization communications could not start.	Check the WDT data updating for the host controller.	Update the WDT data at the host controller correctly.	Gr.2	Available
	A SERVOPACK fault occurred.	–	Turn the power supply OFF and then ON again. If the alarm still occurs, the SERVOPACK may be faulty. Replace the SERVOPACK.		
A.E60: Reception Error in MECHATROLINK Communications	MECHATROLINK-II wiring is incorrect.	Check the MECHATROLINK-II wirings.	Correct the MECHATROLINK-II wiring. Connect the terminator correctly.	Gr.2	Available
	MECHATROLINK-II data reception error occurred due to noise interference.	–	Take measures against noise. Check the MECHATROLINK-II communications cable and FG wiring and take measures such as adding ferrite core on the MECHATROLINK-II communications cable.		
	A SERVOPACK fault occurred.	–	Turn the power supply OFF and then ON again. If the alarm still occurs, the SERVOPACK may be faulty. Replace the SERVOPACK.		
A.E61: Synchronization Interval Error in MECHATROLINK Transmission Cycle	MECHATROLINK-II transmission cycle fluctuated.	Check the MECHATROLINK-II transmission cycle setting.	Remove the cause of transmission cycle fluctuation at host controller.	Gr.2	Available
	A SERVOPACK fault occurred.	–	Turn the power supply OFF and then ON again. If the alarm still occurs, the SERVOPACK may be faulty. Replace the SERVOPACK.		

Continued on next page.

Continued from previous page.

Alarm Number: Alarm Name (Alarm Description)	Cause	Investigative Actions	Corrective Actions	SERVOPACK Side	
				Servomotor Stopping Method	Alarm Reset
A.EA2: DRV Alarm 2 (SERVOPACK WDC Error)	MECHATROLINK-II transmission cycle fluctuated.	Check the MECHATROLINK-II transmission cycle setting.	Remove the cause of transmission cycle fluctuation at host controller.	Gr.2	Available
	A SERVOPACK fault occurred.	–	Turn the power supply OFF and then ON again. If the alarm still occurs, the SERVOPACK may be faulty. Replace the SERVOPACK.		
A.ED1: Command Execution Timeout	A timeout error occurred when using an MECHATROLINK command.	Check the motor status when the command is executed.	Execute the SV_ON or SENS_ON command only when the motor is not running.	Gr.2	Available
		Check the external encoder status when the command is executed.	Execute the SENS_ON command only when an external scale is connected.		

7.2 List of Warnings

The following table shows warnings that are related to communications or commands and that may occur in MECHATROLINK-II communications.



If an error is found in the command or data that a SERVOPACK has received, the SERVOPACK returns the corresponding warning number.

At the same time, the warning number is displayed on the SERVOPACK.

Warning Number: Warning Name (Warning Description)	Cause	Investigative Actions	Corrective Actions
A.94A Data Setting Warning 1 (Parameter Number Error)	Disabled parameter number was used.	Determine the command that caused the alarm. Refer to the following section for the determination method.  7.3 Monitoring Communication Data on Occurrence of an Alarm or Warning on page 7-7	Use the correct parameter number.
A.94B Data Setting Warning 2 (Out of Range)	Attempted to send values outside the range to the command data.	Determine the command that caused the alarm. Refer to the following section for the determination method.  7.3 Monitoring Communication Data on Occurrence of an Alarm or Warning on page 7-7	Set the value of the parameter within the allowable range.
A.94C Data Setting Warning 3 (Calculation Error)	Calculation result of set value is incorrect.	Determine the command that caused the alarm. Refer to the following section for the determination method.  7.3 Monitoring Communication Data on Occurrence of an Alarm or Warning on page 7-7	Set the value of the parameter within the allowable range.
A.94D Data Setting Warning 4 (Parameter Size)	Parameter size set in command is incorrect.	Determine the command that caused the alarm. Refer to the following section for the determination method.  7.3 Monitoring Communication Data on Occurrence of an Alarm or Warning on page 7-7	Use the correct parameter size.
A.94E Data Setting Warning 5 (Latch Mode Error)	Latch mode error is detected.	Determine the command that caused the alarm. Refer to the following section for the determination method.  7.3 Monitoring Communication Data on Occurrence of an Alarm or Warning on page 7-7	Change the setting value of Pn850 or the LT_MOD data for the LTMOD_ON command sent by the host controller to the proper value.
A.95A Command Warning 1 (Unsatisfied Command Conditions)	Command sending condition is not satisfied.	Determine the command that caused the alarm. Refer to the following section for the determination method.  7.3 Monitoring Communication Data on Occurrence of an Alarm or Warning on page 7-7	Send a command after command sending condition is satisfied.
A.95B Command Warning 2 (Unsupported Command)	SERVOPACK received unsupported command.	Determine the command that caused the alarm. Refer to the following section for the determination method.  7.3 Monitoring Communication Data on Occurrence of an Alarm or Warning on page 7-7	Do not sent an unsupported command.

Continued on next page.

Continued from previous page.

Warning Number: Warning Name (Warning Description)	Cause	Investigative Actions	Corrective Actions
A.95D Command Warning 4 (Command Interference)	Command sending condition for latch-related commands is not satisfied.	Determine the command that caused the alarm. Refer to the following section for the determination method.  7.3 Monitoring Communication Data on Occurrence of an Alarm or Warning on page 7-7	Send a command after command sending condition is satisfied.
A.95E Subcommand Warning 5 (Subcommand Not Possible)	Subcommand sending condition is not satisfied.	Determine the command that caused the alarm. Refer to the following section for the determination method.  7.3 Monitoring Communication Data on Occurrence of an Alarm or Warning on page 7-7	Send a command after command sending condition is satisfied.
A.95F Command Warning 6 (Undefined Command)	Undefined command was sent.	Determine the command that caused the alarm. Refer to the following section for the determination method.  7.3 Monitoring Communication Data on Occurrence of an Alarm or Warning on page 7-7	Do not use an undefined command.
A.960 MECHATROLINK Communications Warning	MECHATROLINK-II wiring is incorrect.	Confirm the wiring.	Correct the MECHATROLINK-II wiring. Or, connect a terminal to the terminal station.
	MECHATROLINK-II data reception error occurred due to noise interference.	Confirm the installation conditions.	Take measures against noise. Check the MECHATROLINK-II communications cable and FG wiring and take measures such as adding ferrite core on the MECHATROLINK-II communications cable.
	A SERVOPACK fault occurred.	-	A fault occurred in the SERVOPACK. Replace the SERVOPACK.

Note: Use Pn800 = n.□X□□ to control warning detection.

7.3

Monitoring Communication Data on Occurrence of an Alarm or Warning

You can monitor the command data that is received when an alarm or warning occurs, such as a data setting warning (A.94□) or a command warning (A.95□) by using the following parameters. The following is an example of the data when an alarm or warning has occurred in the normal state.

Command Data during Alarms and Warnings: Pn890 to Pn89E

Response Data during Alarms and Warnings: Pn8A0 to Pn8AE

Command Byte Sequence	Command Data Storage When an Alarm or Warning Occurs	
	CMD	RSP
1	Pn890 = n.□□□□□□XX	Pn8A0 = n.□□□□□□XX
2	Pn890 = n.□□□□XX□□	Pn8A0 = n.□□□□XX□□
3	Pn890 = n.□□XX□□□□	Pn8A0 = n.□□XX□□□□
4	Pn890 = n.XX□□□□□□	Pn8A0 = n.XX□□□□□□
5 to 8	Pn892	Pn8A2
9 to 12	Pn894	Pn8A4
13 to 16	Pn896	Pn8A6
17 to 20	Pn898	Pn8A8
21 to 24	Pn89A	Pn8AA
25 to 28	Pn89C	Pn8AC
29 to 32	Pn89E	Pn8AE

Note: Data is stored in little endian byte order and displayed in the hexadecimal.

Appendix



8.1 Brake Control Commands 8-2

8.2 General-purpose Servo Control Command . . 8-6

8.1 Brake Control Commands

Command Code	Command	Function
21 hex	BRK_ON	Turns the brake signal off and applies the holding brake.
22 hex	BRK_OFF	Turns the brake signal on and releases the holding brake.

BRK_ON (Apply Brake) Command: 21 Hex

The specifications of the BRK_ON command are described below.

Byte	BRK_ON		Description			
	Command	Response				
1	21 hex	21 hex	Phases in which the command can be executed	Phase 2 and 3	Synchronization classification	Asynchronous command
2	-	ALARM	Processing time	Within communications cycle	Subcommand	Cannot be used
3		STATUS	<ul style="list-style-type: none"> Turns the brake signal (/BK) off and apply brake. This command is enabled only while the servo is OFF. This command is enabled while Pn50F is not set to n.□0□□. Brake signal output timing 			
4						
5						
6		MONITOR1				
7						
8						
9						
10		MONITOR2				
11						
12						
13		SEL_MON1/2		SEL_MON1/2		
14		-		IO_MON		
15	-	IO_MON				
16	WDT	RWDT				

Combinations of BRK_ON (21 Hex) with Subcommands

The following table shows which subcommands can be combined with the BRK_ON command.

Main Command	Subcommand							
	NOP	PRM_RD	PRM_WR	ALM_RD	PPRM_WR	LTMOD_ON	LTMOD_OFF	SMON
BRK_ON	√	x	x	x	x	x	x	√

Note: √: Can be combined, x: Can not be combined

BRK_OFF (Release Brake) Command: 22 Hex

The specifications of the BRK_OFF command are described below.

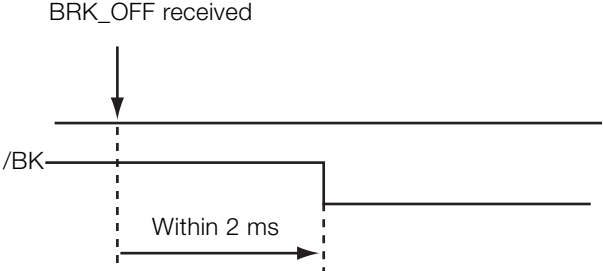
Byte	BRK_OFF		Description			
	Command	Response				
1	22 hex	22 hex	Phases in which the command can be executed	Phase 2 and 3	Synchronization classification	Asynchronous command
2	-	ALARM	Processing time	Within communications cycle	Subcommand	Cannot be used
3		STATUS	<ul style="list-style-type: none"> Turns the brake signal (/BK) ON and releases the brake. This command is enabled while Pn50F is not set to n.□0□□. Brake signal output timing 			
4						
5						
6		MONITOR1				
7						
8						
9		MONITOR2				
10						
11						
12						
13	SEL_MON1/2	SEL_MON1/2				
14	-	IO_MON				
15						
16	WDT	RWDT				



Important

BRK_ON and BRK_OFF commands are always valid as command as long as no warning occurs. Therefore, sending BRK_OFF command while the servomotor is being powered (Servo ON) will not change the operation status. However, it is very dangerous to send SV_OFF command in the above status since the brake is kept released. Always make sure of the status of brake control command when using BRK_ON or BRK_OFF command.

Combinations of BRK_OFF (22 Hex) with Subcommands

The following table shows which subcommands can be combined with the BRK_OFF command.

Main Command	Subcommand							
	NOP	PRM_RD	PRM_WR	ALM_RD	PPRM_WR	LTMOD_ON	LTMOD_OFF	SMON
BRK_OFF	√	x	x	x	x	x	x	√

Note: √: Can be combined, x: Can not be combined

Operation for MECHATROLINK Communications Errors

If any of the MECHATROLINK communications errors listed in the following table occurs while the brake signal is being controlled by the BRK_OFF or BRK_ON command, the brake signal will be output according to the setting of Pn884 = n.□□□X (MECHATROLINK Communications Error Holding Brake Signal Setting). If any other alarm occurs, the status that is set by the BRK_ON or BRK_OFF command will be maintained regardless of the setting of Pn884 = n.□□□X.

Note: Software version 0029 or higher is required to use this function. You can confirm the software version with Fn012.

Refer to the following manual for details.

📖 Σ-7-Series Σ-7S SERVOPACK with MECHATROLINK-II Communications References Product Manual (Manual No.: SIEP S800001 27)

Alarm Number	Alarm Name
A.E50	MECHATROLINK Synchronization Error
A.E60	Reception Error in MECHATROLINK Communications
A.E61	Synchronization Interval Error in MECHATROLINK Transmission Cycle

◆ Parameter Setting

Set the operation for a MECHATROLINK communications error using the following parameter.

Parameter	Meaning	When Enabled	Classification
Pn884	n.□□□0 [Factory setting]	Immediately	Setup
	n.□□□1		

◆ Brake Signal Timing Charts for MECHATROLINK Communications Error Operation Settings

■ When Pn884 = n.□□□X Is Set to 0 and for Software Version 0028 or Lower

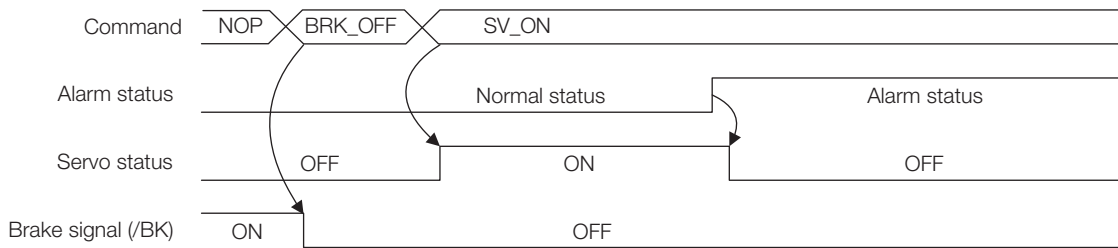

■ When Pn884 = n.□□□X Is Set to 1

- The following timing chart applies when a MECHATROLINK communications error-related alarm occurs.

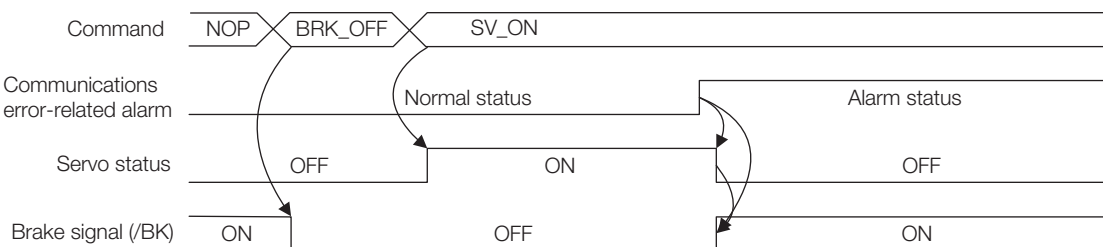

- The following timing chart applies when any alarm other than a MECHATROLINK communications error-related alarm occurs.

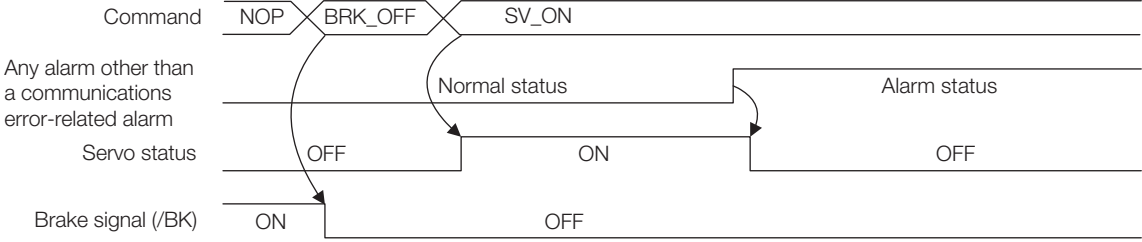

8.2 General-purpose Servo Control Command

The specifications of general-purpose servo control command are described below.

Byte	SVCTRL		Description			
	Command	Response				
1	3F hex	3F hex	Phases in which the command can be executed	Phase 2 and 3	Synchronization classification	Asynchronous command
2	SUBCTRL	ALARM	Processing time	Depends on processing	Subcommand	Can be used
3	OPTION	STATUS	<ul style="list-style-type: none"> This command is compatible with MECHATROLINK versions before Ver 1.0. It is used to perform the general-purpose servo control. Latch Processing Supported. Select the latch signal using L_SGN in SUBCTRL and set SET_L to 1. When the selected latch signal is input, L_CMP in STATUS field will become 1. Perform latch processing again after setting SET_L to 0. The latch signal cannot be changed while SET_L = 1. Motion Any of the motions selected for Motion Selection is executed. Sequence Signals Any of the sequence signals listed in the following table is input. 			
4						
5	TOPS	MONITOR1				
6						
7						
8						
9	TSPD/VFF	MONITOR2				
10						
11						
12						
13	SEL_MON1/2	SEL_MON1/2				
14	SQ_CMD	IO_MON				
15						
16	WDT	RWDT				
17	Subcommand area	Subcommand area				
18						
19						
20						
21						
22						
23						
24						
25						
26						
27						
28						
29						

■ Sub-control (SUBCTRL)

D7	D6	D5	D4	D3	D2	D1	D0
RESERVE 0	MOTION Select motion			RESERVE 0	SET_L Latch command	L_SGN Select latch signal	

Select Motion (MOTION)

D6	D5	D4	Motion	
0	0	0	HOLD	<ul style="list-style-type: none"> During phase 1, an A.95 alarm (Command Warning 1) will occur for POSING and FEED, and the command will be ignored. For INTERPOLATED, in all other phases except phase 3, an A.95A alarm (Command Warning 1) will occur and the command will be ignored.
0	0	1	INTERPOLATE	
0	1	0	FEED	
0	1	1	POSING	

■ Select Latch Signal (L_SGN)

D1	D0	Latch Signal	Meaning
0	0	Phase C	Encoder zero-point signal
0	1	EXT1	External latch signal 1
1	0	EXT2	External latch signal 2
1	1	EXT3	External latch signal 2

■ Sequence Signals: SQ_CMD

D7	D6	D5	D4	D3	D2	D1	D0
Reserved	Reserved	Reserved	Reserved	ACLR Alarm clear	SEN Sensor ON	BRK Brake ON	SON Servo ON

■ Combination of SVCTRL (3F) and Subcommands

CODE	Main Com- mand	Subcommand						
		NOP	PRM_WR	ALM_RD	PPRM_WR	LTMOD_ON	LTMOD_OFF	SMON
3F	SVCTRL	√	√	√	√	×	√	√

Note: √: Can be combined, ×: Can not be combined

Revision History

The date of publication, revision number, and web revision number are given at the bottom right of the back cover. Refer to the following example.

MANUAL NO. SIEP S800001 30B <1>-1
 Published in Japan January 2017

└─── Web revision number
 └─── Revision number
 └─── Date of publication

Date of Publication	Rev. No.	Web Rev. No.	Section	Revised Contents
August 2021	<6>	0	All chapters	Partly revised.
August 2020	<5>	0	Preface, 6.2.1	Partly revised.
February 2020	<4>	0	6.2.1	Addition: Information on Linear Encoder from Canon Precision Inc.
			Back cover	Revision: Address
October 2019	<3>	0	6.2.1	Revision: ■ Feedback Resolution of Linear Encode
March 2019	<2>	0	Preface	Revision: Partly revised
			6.2.1	Addition: Contents of Rotary Servomotor (SGM7M model)
			Back cover	Revision: Address
May 2017	<1>	1	2.1.4	Revision: Information on Monitor Mode
			3.1.7	Revision: Information on parameter settings
			Back cover	Revision: Address
January 2017	-	-	Front cover	Revision: Format
			Back cover	Revision: Address and format
			Preface, 6.2.1	Partly revised.
April 2014	-	-	-	First edition

Σ-7-Series AC Servo Drive

MECHATROLINK-II Communications

Command Manual

IRUMA BUSINESS CENTER (SOLUTION CENTER)

480, Kamifujisawa, Iruma, Saitama, 358-8555, Japan
Phone: +81-4-2962-5151 Fax: +81-4-2962-6138
www.yaskawa.co.jp

YASKAWA AMERICA, INC.

2121, Norman Drive South, Waukegan, IL 60085, U.S.A.
Phone: +1-800-YASKAWA (927-5292) or +1-847-887-7000 Fax: +1-847-887-7310
www.yaskawa.com

YASKAWA ELÉTRICO DO BRASIL LTDA.

777, Avenida Piraporinha, Diadema, São Paulo, 09950-000, Brasil
Phone: +55-11-3585-1100 Fax: +55-11-3585-1187
www.yaskawa.com.br

YASKAWA EUROPE GmbH

Hauptstraße 185, 65760 Eschborn, Germany
Phone: +49-6196-569-300 Fax: +49-6196-569-398
www.yaskawa.eu.com E-mail: info@yaskawa.eu.com

YASKAWA ELECTRIC KOREA CORPORATION

35F, Three IFC, 10 Gukjegeumyung-ro, Yeongdeungpo-gu, Seoul, 07326, Korea
Phone: +82-2-784-7844 Fax: +82-2-784-8495
www.yaskawa.co.kr

YASKAWA ASIA PACIFIC PTE. LTD.

30A, Kallang Place, #06-01, 339213, Singapore
Phone: +65-6282-3003 Fax: +65-6289-3003
www.yaskawa.com.sg

YASKAWA ELECTRIC (THAILAND) CO., LTD.

59, 1F-5F, Flourish Building, Soi Ratchadapisek 18, Ratchadapisek Road, Huaykwang, Bangkok, 10310, Thailand
Phone: +66-2-017-0099 Fax: +66-2-017-0799
www.yaskawa.co.th

YASKAWA ELECTRIC (CHINA) CO., LTD.

22F, Link Square 1, No.222, Hubin Road, Shanghai, 200021, China
Phone: +86-21-5385-2200 Fax: +86-21-5385-3299
www.yaskawa.com.cn

YASKAWA ELECTRIC (CHINA) CO., LTD. BEIJING OFFICE

Room 1011, Tower W3 Oriental Plaza, No.1, East Chang An Avenue,
Dong Cheng District, Beijing, 100738, China
Phone: +86-10-8518-4086 Fax: +86-10-8518-4082

YASKAWA ELECTRIC TAIWAN CORPORATION

12F, No. 207, Section 3, Beishin Road, Shindian District, New Taipei City 23143, Taiwan
Phone: +886-2-8913-1333 Fax: +886-2-8913-1513 or +886-2-8913-1519
www.yaskawa.com.tw

YASKAWA

YASKAWA ELECTRIC CORPORATION

In the event that the end user of this product is to be the military and said product is to be employed in any weapons systems or the manufacture thereof, the export will fall under the relevant regulations as stipulated in the Foreign Exchange and Foreign Trade Regulations. Therefore, be sure to follow all procedures and submit all relevant documentation according to any and all rules, regulations and laws that may apply. Specifications are subject to change without notice for ongoing product modifications and improvements.

© 2014 YASKAWA ELECTRIC CORPORATION

MANUAL NO. SIEP S800001 30G <6>-0

Published in Japan August 2021

19-10-16

Original instructions